



D-Link iSCSI IP SAN storage

GbE iSCSI to SATA II / SAS

RAID IP SAN storage

DSN-6110 & DSN-6120

User Manual

Version 1.0

Preface

Copyright

Copyright©2011, D-Link Corporation. All rights reserved. No part of this manual may be reproduced or transmitted without written permission from **D-Link** corporation.

Trademarks

All products and trade names used in this manual are trademarks or registered trademarks of their respective companies.

About this manual

This manual is the introduction of **D-Link DSN-61x0** IP SAN storage and it aims to help users know the operations of the disk array system easily. Information contained in this manual has been reviewed for accuracy, but not for product warranty because of the various environments / OS / settings. Information and specification herein are subject to change without notice. For any update information, please visit www.dlink.com.

Model comparison

DSN-6100 series adopt 2U12 form factor for all models. **DSN-61x0** IP SAN storages stand for the following models.

DSN-6120: Dual controllers.

DSN-6110: Single controller, can be upgradable to dual mode.

The dual controller specific functions such as dual-active, cache mirroring, flexible RG ownership management, management port seamless take-over, no system down time, and etc are not available in **DSN-6110**.



Caution

Do not attempt to service, change, disassemble or upgrade the equipment's components by yourself. Doing so may violate your warranty and expose you to electric shock. Refer all servicing to authorized service personnel. Please always follow the instructions in this user's manual.

Table of Contents

Chapter 1	Overview	6
1.1	Features	6
1.1.1	Highlights	7
1.2	RAID concepts	8
1.2.1	Terminology	8
1.2.2	RAID levels.....	10
1.2.3	Volume relationship.....	11
1.3	iSCSI concepts	11
1.4	IP SAN storage specifications	13
1.4.1	Technical specifications.....	13
1.4.2	FCC and CE statements.....	16
Chapter 2	Installation	18
2.1	Package contents.....	18
2.2	Before installation	18
2.3	Enclosure	18
2.3.1	Front view	18
2.3.2	Front LED lights	19
2.3.3	Install drives.....	20
2.3.4	Rear view	21
2.4	Install battery backup module	23
2.5	Deployment.....	25
Chapter 3	Quick setup.....	27
3.1	Management interfaces	27
3.1.1	Serial console	27
3.1.2	Remote control.....	27
3.1.3	Web UI.....	27
3.2	How to use the system quickly	30
3.2.1	Quick installation.....	30
3.2.2	Volume creation wizard.....	32
Chapter 4	Configuration	35
4.1	Web UI management interface hierarchy	35
4.2	System configuration	36
4.2.1	System setting	36
4.2.2	Network setting.....	37
4.2.3	Login setting	37
4.2.4	Mail setting.....	38
4.2.5	Notification setting	39
4.3	iSCSI configuration	41
4.3.1	NIC.....	41
4.3.2	Entity property	44
4.3.3	Node	44
4.3.4	Session.....	47
4.3.5	CHAP account	48
4.4	Volume configuration.....	49

4.4.1	Physical disk.....	49
4.4.2	RAID group.....	53
4.4.3	Virtual disk.....	56
4.4.4	Snapshot.....	61
4.4.5	Logical unit.....	63
4.4.6	Example.....	65
4.5	Enclosure management.....	69
4.5.1	Hardware monitor.....	70
4.5.2	UPS.....	71
4.5.3	SES.....	73
4.5.4	Hard drive S.M.A.R.T.....	73
4.6	System maintenance.....	74
4.6.1	System information.....	74
4.6.2	Event log.....	75
4.6.3	Upgrade.....	77
4.6.4	Firmware synchronization.....	77
4.6.5	Reset to factory default.....	78
4.6.6	Import and export.....	78
4.6.7	Reboot and shutdown.....	79
4.7	Home/Logout/Mute.....	79
4.7.1	Home.....	79
4.7.2	Logout.....	79
4.7.3	Mute.....	79
Chapter 5	Advanced operations.....	80
5.1	Volume rebuild.....	80
5.2	RG migration.....	82
5.3	VD extension.....	83
5.4	Snapshot.....	84
5.4.1	Create snapshot volume.....	85
5.4.2	Auto snapshot.....	86
5.4.3	Rollback.....	87
5.4.4	Snapshot constraint.....	87
5.5	Disk roaming.....	89
5.6	VD clone.....	90
5.7	SAS JBOD expansion.....	97
5.7.1	Connecting JBOD.....	97
5.7.2	Upgrade firmware of JBOD.....	97
5.8	MPIO and MC/S.....	98
5.9	Trunking and LACP.....	100
5.10	Dual controllers (only for DSN-6120).....	101
5.10.1	Perform I/O.....	101
5.10.2	Ownership.....	102
5.10.3	Controller status.....	103
5.11	Replication.....	104
5.12	VLAN.....	114
Chapter 6	Troubleshooting.....	117
6.1	System buzzer.....	117

6.2	Event notifications	117
A.	Certification list	123
B.	Microsoft iSCSI initiator.....	126
C.	From single controller to Dual controller	132

Chapter 1 Overview

1.1 Features

D-Link DSN-6000 series IP SAN storage provides non-stop service with a high degree of fault tolerance by using **D-Link** RAID technology and advanced array management features.

DSN-6110/6120 IP SAN storage connects to the host system by iSCSI interface. It can be configured to numerous RAID level. The IP SAN storage provides reliable data protection for servers by using RAID 6. The RAID 6 allows two HDD failures without any impact on the existing data. Data can be recovered from the existing data and parity drives. (Data can be recovered from the rest drives.)



Figure 1.1.1 (DSN-6110/6120)

Snapshot-on-the-box is a fully usable copy of a defined collection of data that contains an image of the data as it appeared at the point in time, which means a point-in-time data replication. It provides consistent and instant copies of data volumes without any system downtime. Snapshot-on-the-box can keep up to 32 snapshots for one logical volume. Rollback feature is provided for restoring the previous-snapshot data easily while continuously using the volume for further data access. The data access which includes read / write is working as usual without any impact to end users. The "on-the-box" implies that it does not require any proprietary agents installed at host side. The snapshot is taken at target side. It will not consume any host CPU time thus the server is dedicated to the specific or other application. The snapshot copies can be taken manually or by schedule every hour or every day, depends on the modification.

D-Link IP SAN storage is the most cost-effective disk array system with completely integrated high-performance and data-protection capabilities which meet or exceed the highest industry standards, and **the best data solution for small / medium business (SMB) and enterprise users.**

1.1.1 Highlights

- D-Link DSN-6110/6120 feature highlights

Host Interface	8 x iSCSI GbE ports (DSN-6120) 4 x iSCSI GbE ports (DSN-6110)
Drive Interface	12 x SAS or SATA II
RAID Controllers	Single controller, can be upgradable to dual (DSN-6110) Dual-active RAID controllers (DSN-6120)
Scalability	SAS JBOD expansion port
Green	Auto disk spin-down Advanced cooling
RAID Level	RAID 0, 1, 0+1, 3, 5, 6, 10, 30, 50, 60 and JBOD N-way mirror
Compatibility	Support multiple Oses, applications, iSCSI HBA, software initiators, and etc.
Virtualization	VMWare, Hyper-V, Citrix
Data Protection	Snapshot (Read only and Writeable), Storage base Replication
Connection Availability	Load balancing and failover support on the iSCSI GbE ports
Dimension (W x D x H)	442.8 x 500.6 x 88.0 (mm)
Power Supply	2 x 500W PSU
Cache Protection	Hot pluggable battery backup module
Fan	Redundant

1.2 RAID concepts

RAID is the abbreviation of “**R**edundant **A**rray of **I**ndependent **D**isks”. The basic idea of RAID is to combine multiple drives together to form one large logical drive. This RAID drive obtains performance, capacity and reliability than a single drive. The operating system detects the RAID drive as a single storage device.

1.2.1 Terminology

The document uses the following terms:

- **Part 1: Common**

RAID	R edundant A rray of I ndependent D isks. There are different RAID levels with different degree of data protection, data availability, and performance to host environment.
PD	The P hysical D isk belongs to the member disk of one specific RAID group.
RG	R aid G roup. A collection of removable media. One RG consists of a set of VDs and owns one RAID level attribute.
VD	V irtual D isk. Each RD could be divided into several VDs. The VDs from one RG have the same RAID level, but may have different volume capacity.
LUN	L ogical U nit N umber. A logical unit number (LUN) is a unique identifier which enables it to differentiate among separate devices (each one is a logical unit).
GUI	G raphic U ser I nterface.
RAID cell	When creating a RAID group with a compound RAID level, such as 10, 30, 50 and 60, this field indicates the number of subgroups in the RAID group. For example, 8 disks can be grouped into a RAID group of RAID 10 with 2 cells, 4 cells. In the 2-cell case, PD {0, 1, 2, 3} forms one RAID 1 subgroup and PD {4, 5, 6, 7} forms another RAID 1 subgroup. In the 4-cells, the 4 subgroups are PD {0, 1}, PD {2, 3}, PD {4, 5} and PD {6,7}.
WT	W rite- T hrough cache-write policy. A caching technique in which the completion of a write request is not signaled until data is safely stored in non-volatile media. Each data is synchronized in

	both data cache and accessed physical disks.
WB	Write-Back cache-write policy. A caching technique in which the completion of a write request is signaled as soon as the data is in cache and actual writing to non-volatile media occurs at a later time. It speeds up system write performance but needs to bear the risk where data may be inconsistent between data cache and the physical disks in one short time interval.
RO	Set the volume to be Read-Only .
DS	Dedicated Spare disks. The spare disks are only used by one specific RG. Others could not use these dedicated spare disks for any rebuilding purpose.
GS	Global Spare disks. GS is shared for rebuilding purpose. If some RGs need to use the global spare disks for rebuilding, they could get the spare disks out from the common spare disks pool for such requirement.
DG	DeGraded mode. Not all of the array's member disks are functioning, but the array is able to respond to application read and write requests to its virtual disks.
SCSI	Small Computer Systems Interface .
SAS	Serial Attached SCSI .
S.M.A.R.T.	Self-Monitoring Analysis and Reporting Technology .
WWN	World Wide Name .
HBA	Host Bus Adapter .
SES	SCSI Enclosure Services .
NIC	Network Interface Card .
BBM	Battery Backup Module

- **Part 2: iSCSI**

iSCSI	Internet Small Computer Systems Interface .
LACP	Link Aggregation Control Protocol .

MPIO	Multi-Path Input/Output.
MC/S	Multiple Connections per Session
MTU	Maximum Transmission Unit.
CHAP	Challenge Handshake Authentication Protocol. An optional security mechanism to control access to an iSCSI storage system over the iSCSI data ports.
iSNS	Internet Storage Name Service.

- **Part 3: Dual controller**

SBB	Storage Bridge Bay. The objective of the Storage Bridge Bay Working Group (SBB) is to create a specification that defines mechanical, electrical and low-level enclosure management requirements for an enclosure controller slot that will support a variety of storage controllers from a variety of independent hardware vendors ("IHVs") and system vendors.
------------	---

1.2.2 RAID levels

There are different RAID levels with different degree of data protection, data availability, and performance to host environment. The description of RAID levels are on the following:

RAID 0	Disk striping. RAID 0 needs at least one hard drive.
RAID 1	Disk mirroring over two disks. RAID 1 needs at least two hard drives.
N-way mirror	Extension to RAID 1 level. It has N copies of the disk.
RAID 3	Striping with parity on the dedicated disk. RAID 3 needs at least three hard drives.
RAID 5	Striping with interspersed parity over the member disks. RAID 3 needs at least three hard drives.
RAID 6	2-dimensional parity protection over the member disks. RAID 6 needs at least four hard drives.
RAID 0+1	Mirroring of the member RAID 0 volumes. RAID 0+1 needs at least four hard drives.
RAID 10	Striping over the member RAID 1 volumes. RAID 10 needs at least four hard drives.

RAID 30	Striping over the member RAID 3 volumes. RAID 30 needs at least six hard drives.
RAID 50	Striping over the member RAID 5 volumes. RAID 50 needs at least six hard drives.
RAID 60	Striping over the member RAID 6 volumes. RAID 60 needs at least eight hard drives.
JBOD	The abbreviation of “ J ust a B unch O f D isks”. JBOD needs at least one hard drive.

1.2.3 Volume relationship

The below graphic describes the relationship of RAID components. One RG (RAID group) consists of a set of VDs (Virtual Disk) and owns one RAID level attribute. Each RG can be divided into several VDs. The VDs in one RG share the same RAID level, but may have different volume capacity. All VDs share the CV (Cache Volume) to execute the data transaction. LUN (Logical Unit Number) is a unique identifier, in which users can access through SCSI commands.

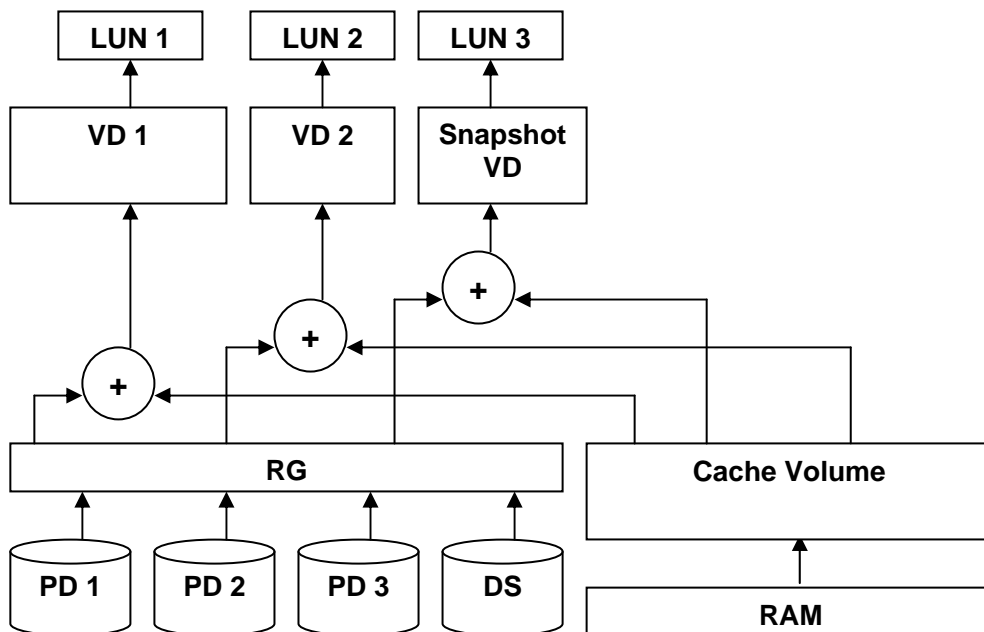

Figure 1.2.3.1

1.3 iSCSI concepts

iSCSI (Internet SCSI) is a protocol which encapsulates SCSI (Small Computer System Interface) commands and data in TCP/IP packets for linking storage devices with servers over common IP infrastructures. iSCSI provides high performance SANs over standard IP networks like LAN, WAN or the Internet.

IP SANs are true SANs (Storage Area Networks) which allow several servers to attach to an infinite number of storage volumes by using iSCSI over TCP/IP networks. IP SANs can scale the storage capacity with any type and brand of storage system. In addition, it can be used by any type of network (Ethernet, Fast Ethernet, Gigabit Ethernet, and 10 Gigabit Ethernet) and combination of operating systems (Microsoft Windows, Linux, Solaris, Mac, etc.) within the SAN network. IP-SANs also include mechanisms for security, data replication, multi-path and high availability.

Storage protocol, such as iSCSI, has “two ends” in the connection. These ends are initiator and target. In iSCSI, we call them iSCSI initiator and iSCSI target. The iSCSI initiator requests or initiates any iSCSI communication. It requests all SCSI operations like read or write. An initiator is usually located on the host side (either an iSCSI HBA or iSCSI SW initiator).

The target is the storage device itself or an appliance which controls and serves volumes or virtual volumes. The target is the device which performs SCSI command or bridge to an attached storage device.

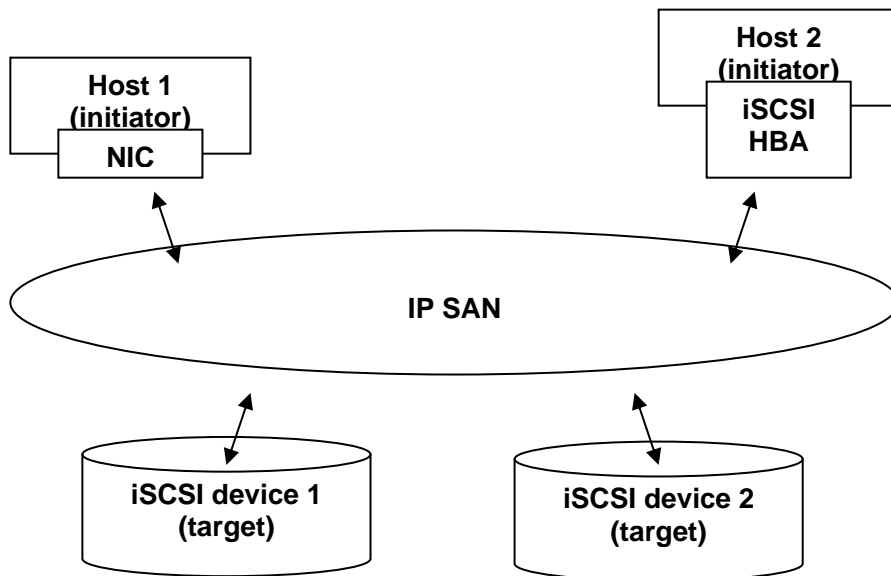

Figure 1.3.1

The host side needs an iSCSI initiator. The initiator is a driver which handles the SCSI traffic over iSCSI. The initiator can be software or hardware (HBA). Please refer to the certification list of iSCSI HBA(s) in Appendix A. OS native initiators or other software initiators use standard TCP/IP stack and Ethernet hardware, while iSCSI HBA(s) use their own iSCSI and TCP/IP stacks on board.

Hardware iSCSI HBA(s) provide its own initiator tool. Please refer to the vendors' HBA user manual. Microsoft, Linux, Solaris and Mac provide iSCSI initiator driver. Please contact **D-Link** for the latest certification list. Below are the available links:

1. Link to download the Microsoft iSCSI software initiator:

<http://www.microsoft.com/downloads/details.aspx?FamilyID=12cb3c1a-15d6-4585-b385-befd1319f825&DisplayLang=en>

2. In current Linux distributions, OS built-in iSCSI initiators are usually available. For different kernels, there are different iSCSI drivers. Please check Appendix A for iSCSI initiator certification list. If user needs the latest Linux iSCSI initiator, please visit Open-iSCSI project for most update information. Linux-iSCSI (sfnet) and Open-iSCSI projects merged in April 11, 2005.

Open-iSCSI website: <http://www.open-iscsi.org/>

Open-iSCSI README: <http://www.open-iscsi.org/docs/README>

Features: <http://www.open-iscsi.org/cgi-bin/wiki.pl/Roadmap>

Support Kernels:

http://www.open-iscsi.org/cgi-bin/wiki.pl/Supported_Kernels

Google groups:

<http://groups.google.com/group/open-iscsi/threads?gvc=2>

<http://groups.google.com/group/open-iscsi/topics>

Open-iSCSI Wiki: <http://www.open-iscsi.org/cgi-bin/wiki.pl>

3. ATTO iSCSI initiator is available for Mac.
Website: <http://www.attotech.com/xtend.html>
4. Solaris iSCSI initiator
Version: Solaris 10 u6 (10/08)

1.4 IP SAN storage specifications

1.4.1 Technical specifications

- **Controller features**

1. Dual-active configuration support (**only for DSN-6120**)
2. Better performance, when comparing to other competitors' products in the same segment
3. Cache mirroring through high bandwidth channels (**only for DSN-6120**)
4. Flexible RAID group (RG) ownership management (**only for DSN-6120**)
 - Each RG can be assigned to one of the two controllers
 - Each LUN can be exported from both controllers
5. Management port seamless take-over (**only for DSN-6120**)
 - The management port can be transferred smoothly to the other controller with the same IP address
6. Online firmware upgrade, no system down time (**only for DSN-6120**)
7. Multiple target iSCSI nodes per controller support
 - Each LUN can be attached to one of 32 nodes from each controller

8. Front-end 4 GbE NIC ports with high availability/load balancing/fail-over support per controller
 - Microsoft MPIO, MC/S, Trunking, LACP, and etc.
9. SBB Compliant

- **System key components**

1. CPU: Intel Xscale IOP 81342
2. Memory: 4GB DDRII 533 DIMM per controller board
3. Hardware iSCSI off-load engine
4. 2 x UARTs: serial console management and UPS
5. Fast Ethernet port for web-based management use
6. Backend: 12 x SAS or SATA II drive connections
7. Front-end: 4x iSCSI GbE ports per controller board
8. LCM for quick management
9. Hot pluggable BBM support
10. SAS JBOD expansion port for expansion
11. Multiplexer board support for SATA drives (optional, on Dual controller mode)
12. Two power supplies
13. Redundant fans

- **RAID and volume operation**

1. RAID level: 0,1,0+1,3,5,6,10,30,50, 60, JBOD, and N-way mirror
2. Up to 1024 logical volumes in the system
3. Up to 32 PDs can be included in one volume group
4. Global and dedicated hot spare disks
5. Write-through or write-back cache policy for different application usage
6. Multiple RAID volumes support
7. Configurable RAID stripe size
8. Online volume expansion
9. Instant RAID volume availability
10. Auto volume rebuilding
11. On-line volume migration with no system down-time

- **Advanced data protection**

1. D-Link writeable snapshot
 - Built-in snapshot with rollback enabled
 - Snapshot enabled up to 16 volumes, each logical volume supports up to 32 snapshot volumes, total 512 snapshot volumes per system
2. Microsoft Windows Volume Shadow Copy Services (VSS)
3. Configurable N-way mirror for high data protection
4. Online disk roaming
5. Instant volume configuration restoration
6. Smart faulty sector relocation
7. Hot pluggable battery backup module support

- **Enclosure monitoring**

1. S.E.S. inband management
2. UPS management via dedicated serial port
3. Fan speed monitors
4. Redundant power supply monitors
5. Voltage monitors
6. Thermal sensors for both RAID controller and enclosure
7. Status monitors for SAS JBODs

- **Management interface**

1. Management UI via
 - serial console
 - SSH telnet
 - HTTP Web UI
 - secured Web (HTTPS)
2. Notification via
 - Email
 - SNMP trap
 - Browser pop-up windows
 - Syslog
 - Windows Messenger
3. iSNS support
4. DHCP support

- **iSCSI features**

1. iSCSI jumbo frame support
2. Header/Data digest support
3. CHAP authentication enabled
4. Load-balancing and failover through MPIO, MC/S, Trunking, and LACP
5. Up to 32 multiple nodes support
6. VLAN support

- **Host connection**

1. 4x GbE ports (**DSN-6110**)/ 8 x GbE ports (**DSN-6120**)
2. Host access control: Read-Write and Read-Only
3. Up to 128 sessions
4. One logic volume can be shared by as many as 16 hosts

- **OS support**

- Windows
- Linux
- Solaris
- Mac

- **Drive support**

1. SAS
2. SATA II (optional, need SATA Bridge board)
3. SCSI-3 compliant
4. Multiple IO transaction processing
5. Tagged command queuing
6. Disk auto spin-down support
7. S.M.A.R.T. for SATA II drives
8. SAS JBODs expansion

- **Power and Environment**

- AC input: 100-240V ~ 7A-4A 500W with PFC (Auto Switching)
- DC output: 3.3V-21A; 5V-39A; 12V-30A
- Operating Temperature: 0 to 40 °C
- Relative Humidity: 5% to 95% non-condensing

- **Dimensions**

2U 12 bay 19 inch rackmount chassis
442.8mm x 500.6mm x 88.0mm (W x D x H)

1.4.2 FCC and CE statements

FCC statement

This device has been shown to be in compliance with and was tested in accordance with the measurement procedures specified in the Standards and Specifications listed below and as indicated in the measurement report number: **XXXXXXXX-F**

Technical Standard: FCC Part 15 Class A (Verification)
IC ICES-003

CE statement

This device has been shown to be in compliance with and was tested in accordance with the measurement procedures specified in the Standards and Specifications listed below and as indicated in the measurement report number: **XXXXXXXX-E**

Technical Standard: EMC DIRECTIVE 2004/108/EC
(EN55022 / EN55024)

UL statement

Rack Mount Instructions - The following or similar rack-mount instructions are included with the installation instructions:

- A. Elevated Operating Ambient - If installed in a closed or multi-unit rack assembly, the operating ambient temperature of the rack environment may be greater than room ambient. Therefore, consideration should be given to installing the equipment in an environment compatible with the maximum ambient temperature (T_{ma}) specified by the manufacturer.
- B. Reduced Air Flow - Installation of the equipment in a rack should be such that the amount of air flow required for safe operation of the equipment is not compromised.
- C. Mechanical Loading - Mounting of the equipment in the rack should be such that a hazardous condition is not achieved due to uneven mechanical loading.
- D. Circuit Overloading - Consideration should be given to the connection of the equipment to the supply circuit and the effect that overloading of the circuits might have on overcurrent protection and supply wiring. Appropriate consideration of equipment nameplate ratings should be used when addressing this concern.
- E. Reliable Earthing - Reliable earthing of rack-mounted equipment should be maintained. Particular attention should be given to supply connections other than direct connections to the branch circuit (e.g. use of power strips).



Caution

The main purpose of the handles is for rack mount use only. Do not use the handles to carry or transport the systems.

The ITE is not intended to be installed and used in a home, school or public area accessible to the general population, and the thumbscrews should be tightened with a tool after both initial installation and subsequent access to the panel.

Warning: Remove all power supply cords before service

This equipment intended for installation in restricted access location.

- Access can only be gained by SERVICE PERSONS or by USERS who have been instructed about the reasons for the restrictions applied to the location and about any precautions that shall be taken.
- Access is through the use of a TOOL or lock and key, or other means of security, and is controlled by the authority responsible for the location.



Caution

Risk of explosion if battery is replaced by incorrect type. Dispose of used batteries according to the instructions.

Chapter 2 Installation

2.1 Package contents

The package contains the following items:

1. **DSN-6110/6120** IP SAN storage (x1)
2. HDD trays (x12)
3. Power cords (x4)
4. RS-232 cables (x2), one is for console, the other is for UPS.
5. CD (x1)
6. Rail kit (x1 set)
7. Keys, screws for drives and rail kit (x1 packet)

2.2 Before installation

Before starting, prepare the following items.

1. A host with a Gigabit Ethernet NIC or iSCSI HBA.
2. CAT 5e, or CAT 6 network cables for management port and iSCSI data ports.
3. Prepare storage system configuration plan.
4. Prepare management port and iSCSI data ports network information. When using static IP, please prepare static IP addresses, subnet mask, and default gateway.
5. Gigabit switches (recommended). Or Gigabit switches with LCAP / Trunking (optional).
6. CHAP security information, including CHAP username and secret (optional).

2.3 Enclosure

2.3.1 Front view



Figure 2.3.1.1 (DSN-6110/6120)

Drive slot numbering

Slot 1	Slot 4	Slot 7	Slot 10
Slot 2	Slot 5	Slot 8	Slot 11
Slot 3	Slot 6	Slot 9	Slot 12

The drives can be installed into any slot in the enclosure. Slot numbering will be reflected in web UI.



Tips

It is advisable to install at least one drive in slots 1 ~ 4. System event logs are saved to drives in these slots; If no drives are fitted the event logs will be lost in the event of a system reboot.

2.3.2 Front LED lights

There are three LED lights on the left frame bar.



Figure 2.3.2.1

- **LED lights description:**

1	Power LED: <ul style="list-style-type: none">• Green → Power on.• Off → Power off.
2	Status LED: <ul style="list-style-type: none">• Red → System is failure.• Off → System is good.
3	Access LED: <ul style="list-style-type: none">• Blue → Host is accessing.• Off → Host is no access.

2.3.3 Install drives

Note : Skip this section if you purchased a solution populated with drives.

To install SAS or SATA drives with no Bridge Board use the front mounting holes:



To install SATA drives with Bridge Board (DSN-654), fit the Bridge Board first



Then install the drive using the rear mounting holes:



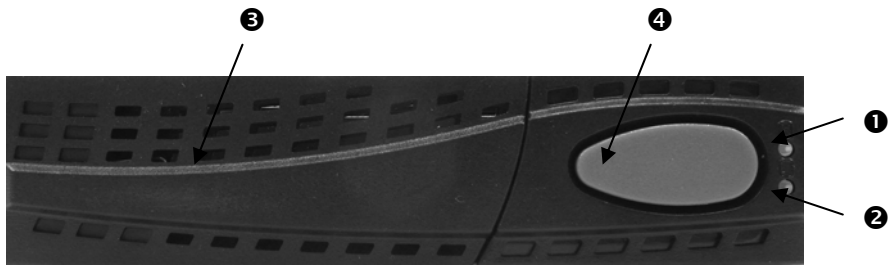

Figure 2.2.3.3

• HDD tray description:

1	HDD power LED: <ul style="list-style-type: none"> • Green → HDD is inserted and good. • Off → No HDD.
2	HDD access LED: <ul style="list-style-type: none"> • Blue blinking → HDD is accessing. • Off → No HDD.
3	HDD tray handhold.
4	Latch for tray kit removal.

2.3.4 Rear view

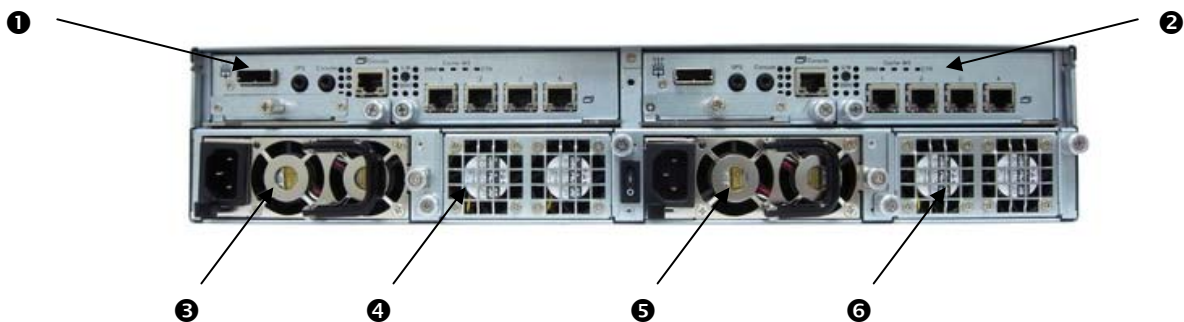

Figure 2.3.4.1 (DSN-6120)

• PSU and Fan module description:

1	Controller 2.
----------	---------------

②	Controller 1.
③	Power supply unit (PSU2).
④	Fan module (FAN3 / FAN4).
⑤	Power supply unit (PSU1).
⑥	Fan module (FAN1 / FAN2).

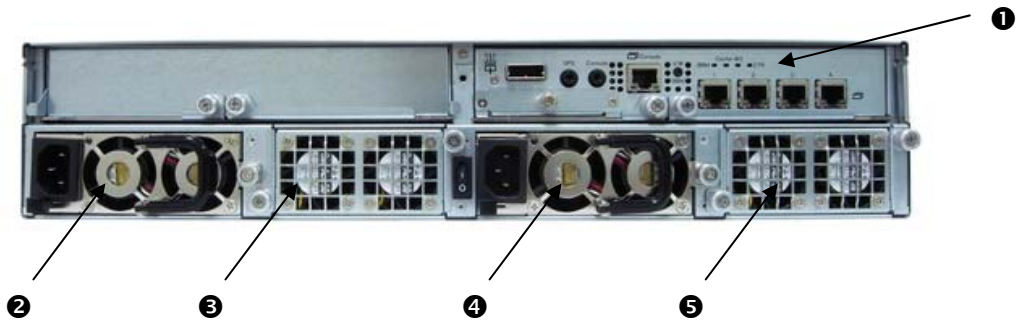

Figure 2.3.4.2 (DSN-6110)

- PSU and Fan module description:

①	Controller.
②	Power supply unit (PSU2).
③	Fan module (FAN3 / FAN4).
④	Power supply unit (PSU1).
⑤	Fan module (FAN1 / FAN2).

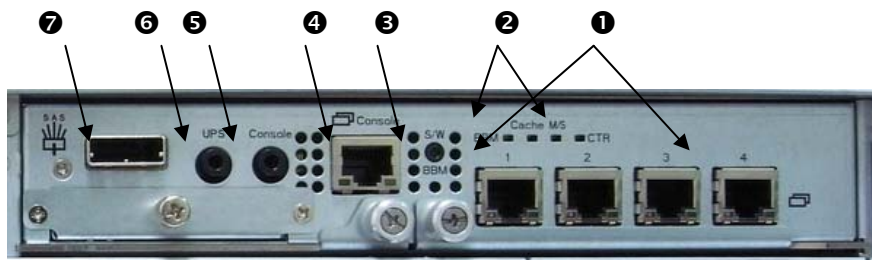

Figure 2.3.4.3 (DSN-6110/6120)

- **Connector, LED and button description:**

❶	Gigabit ports (x4).
❷	<p>LED (from left to right)</p> <p>Controller Health LED:</p> <ul style="list-style-type: none"> • Green → Controller status normal or in the booting. • Red → Other than above status. <p>Master Slave LED: (only for DSN-6120)</p> <ul style="list-style-type: none"> • Green → Master controller. • Off → Slave controller. <p>Dirty Cache LED:</p> <ul style="list-style-type: none"> • Orange → Data on the cache waiting for flush to disks. • Off → No data on the cache. <p>BBM LED:</p> <ul style="list-style-type: none"> • Green → BBM installed and powered • Off → No BBM
❸	<p>BBM Status Button:</p> <ul style="list-style-type: none"> • When the system power is off, press the BBM status button, if the BBM LED is Green, then the BBM still has power to keep data on the cache. If not, then the BBM power is ran out and cannot keep the data on the cache anymore.
❹	Management port.
❺	Console port.
❻	RS 232 port for UPS.
❼	SAS JBOD expansion port.
❽	Power switch.

2.4 Install battery backup module

To install the IP SAN storage with a battery backup module, please follow the procedure.

1. Shutdown IP SAN storage, then power off.
2. Remove the cover of battery backup module.
3. Insert the battery backup module.

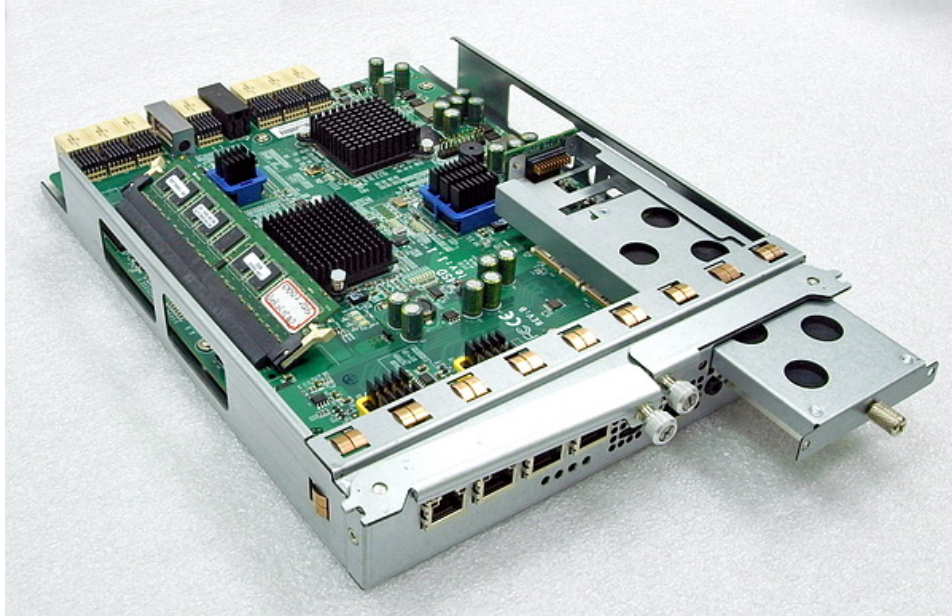

Figure 2.4.1

4. Tighten the screws up.
5. Power on, BBM will work.

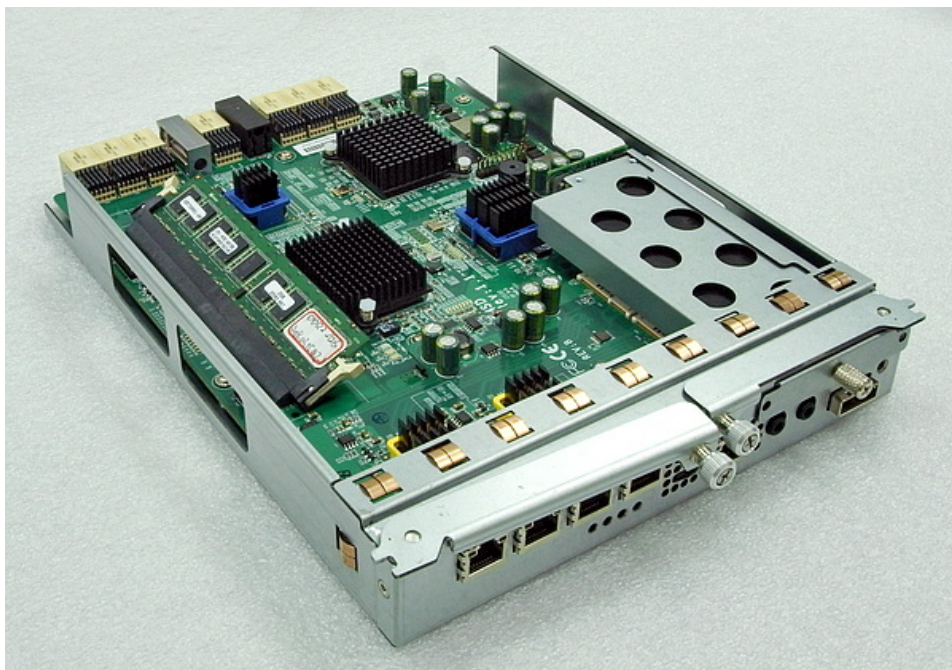

Figure 2.4.2

2.5 Deployment

Please refer to the following topology and have all the connections ready.

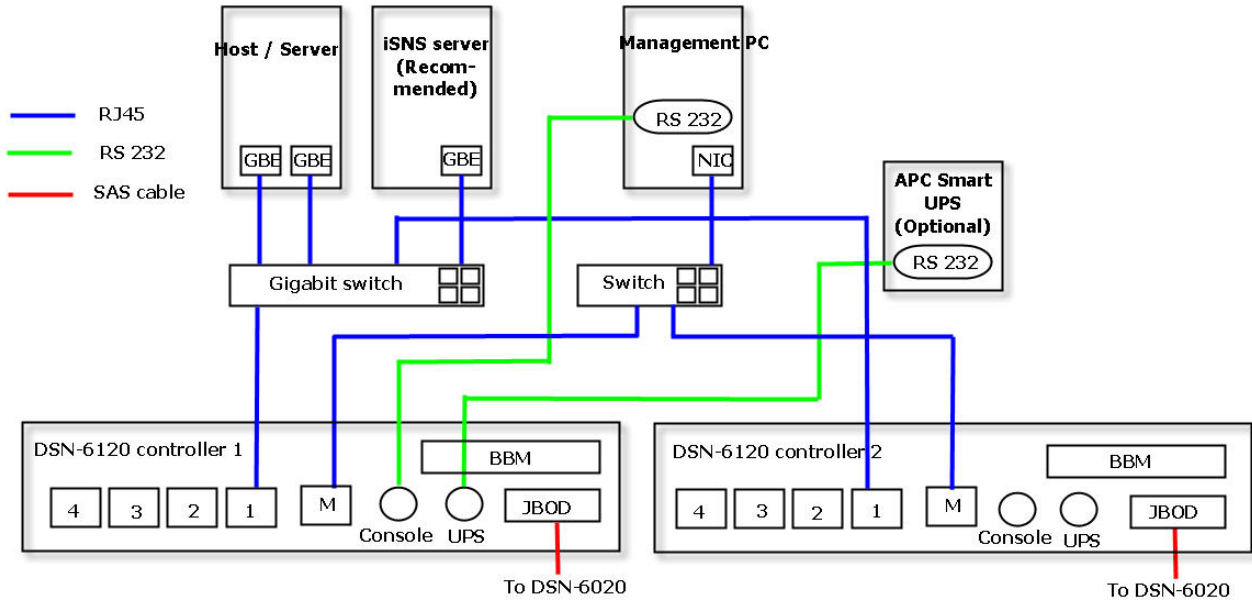

Figure 2.5.1 (DSN-6120)

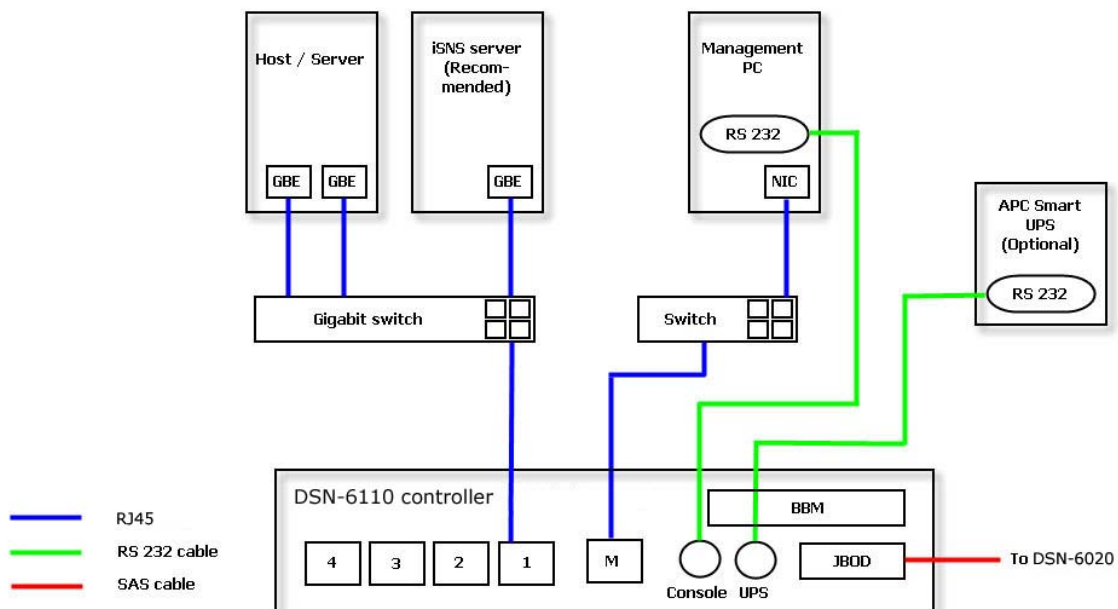

Figure 2.5.2 (DSN-6110)

1. Setup the hardware connection before power on servers. Connect console cable, management port cable, and iSCSI data port cables in advance.
2. In addition, installing an iSNS server is recommended for dual controller system.
3. Power on **DSN-6110/6120** and DSN-6020 (optional) first, and then power on hosts and iSNS server.

- Host server is suggested to logon the target twice (both controller 1 and controller 2), and then MPIO should be setup automatically. **(only for DSN-6120)**



Tips

iSNS server is recommended for dual controller system.

For better data service availability, all the connections among host servers, GbE switches, and the dual controllers are recommended as redundant as below.

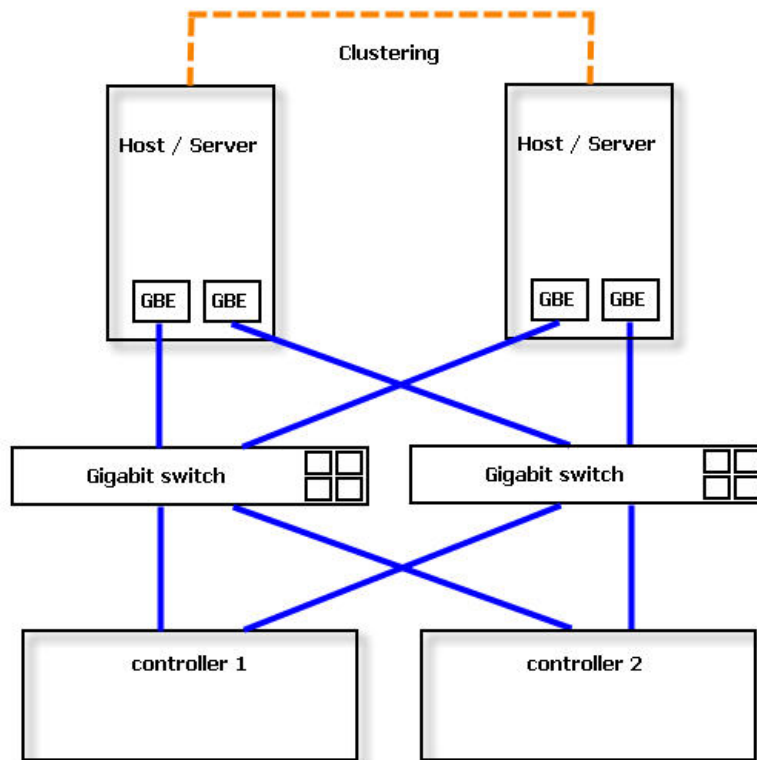

Figure 2.5.3 (only for DSN-6120)

Chapter 3 Quick setup

3.1 Management interfaces

There are three management methods to manage **D-Link** IP SAN storage, describe in the following:

3.1.1 Serial console

Use console cable (NULL modem cable) to connect from console port of **D-Link** IP SAN storage to RS 232 port of management PC. Please refer to figure 2.3.1. The console settings are on the following:

Baud rate: **115200**, 8 data bit, no parity, 1 stop bit, and no flow control.

Terminal type: **VT100**

Login name: **admin**

Default password: **123456**

3.1.2 Remote control

SSH (secure shell) software is required for remote login. The SSH client software is available at the following web site:

SSH Tectia Client: <http://www.ssh.com/>

PuTTY: <http://www.chiark.greenend.org.uk/>

Host name: **192.168.0.32 (Default IP)**

Login name: **admin**

Default password: **123456**



Tips

D-Link product supports SSH for remote control only. For using SSH, the IP address and password are required for login.

3.1.3 Web UI

D-Link IP SAN storage supports graphic user interface (GUI) to operate. Be sure to connect the LAN cable. The default IP setting is 192.168.0.32; open the browser and enter:

http://192.168.0.32

And then it will pop up a dialog for authentication.



Figure 3.1.4.1

User name: **admin**

Default password: **123456**

After login, choose the functions which lists on the left side of window to make any configuration.

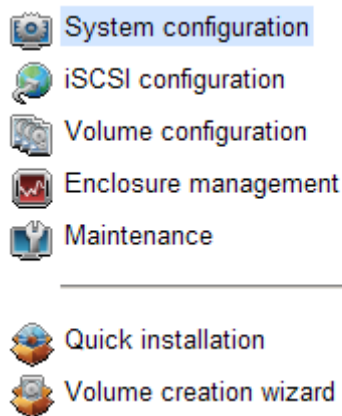



Figure 3.1.4.2









There are seven indicators and three icons at the top-right corner.



Figure 3.1.4.3

- **Indicator description:**

	<p>RAID light:</p> <ul style="list-style-type: none"> • Green → RAID works well. • Red → RAID fails.
---	--

	<p>Temperature light:</p> <ul style="list-style-type: none"> • Green → Temperature is normal. • Red → Temperature is abnormal.
	<p>Voltage light:</p> <ul style="list-style-type: none"> • Green → voltage is normal. • Red → voltage is abnormal.
	<p>UPS light:</p> <ul style="list-style-type: none"> • Green → UPS works well. • Red → UPS fails.
	<p>Fan light:</p> <ul style="list-style-type: none"> • Green → Fan works well. • Red → Fan fails.
	<p>Power light:</p> <ul style="list-style-type: none"> • Green → Power works well. • Red → Power fails.
	<p>Dual controller light:</p> <ul style="list-style-type: none"> • Green → Both controller 1 and controller 2 are present and well. • Orange → The system is degraded and there is only 1 controller alive and well.
	Return to home page.
	Logout the management web UI.
	Mute alarm beeper.



Tips

If the status indicators in Internet Explorer (IE) are displayed in gray, but not in blinking red, please enable "**Internet Options**" → "**Advanced**" → "**Play animations in webpages**" options in IE. The default value is enabled, but some applications will disable it.

3.2 How to use the system quickly

The following methods will describe the quick guide to use this IP SAN storage.

3.2.1 Quick installation

Please make sure that there are some free drives installed in this system. SAS drives are recommended. Please check the hard drive details in “/ **Volume configuration** / **Physical disk**”.

Physical disk													
RAID group													
Virtual disk													
Snapshot													
Logical unit													
Replication													
Show PD for: Local - Show size unit as: GB													
	Slot	Size(GB)	RG	Status	Health	Usage	Vendor	Serial	Type	Write cache	Standby	Readahead	Command queuing
OP	1	68	0	Online	Good	RAID disk	SEAGATE	3LQ41E1T	SAS	Enabled	Disabled	Enabled	Enabled
OP	2	68	0	Online	Good	RAID disk	SEAGATE	3LQ0TLPF	SAS	Enabled	Disabled	Enabled	Enabled
OP	3	68	0	Online	Good	RAID disk	SEAGATE	3LQ1GX3E	SAS	Enabled	Disabled	Enabled	Enabled
OP	4	68	0	Online	Good	RAID disk	SEAGATE	3LQ0TMVJ	SAS	Enabled	Disabled	Enabled	Enabled
OP	5	33	0	Online	Good	RAID disk	SEAGATE	3KQ1VEV8	SAS	Enabled	Disabled	Enabled	Enabled
OP	6	33	0	Online	Good	RAID disk	SEAGATE	3KQ1VMEZ	SAS	Enabled	Disabled	Enabled	Enabled
OP	7	136	0	Online	Good	RAID disk	SEAGATE	3LN6TS1D	SAS	Enabled	Disabled	Enabled	Enabled
OP	8	136	0	Online	Good	RAID disk	SEAGATE	3LN4X8HV	SAS	Enabled	Disabled	Enabled	Enabled
OP	9	465	0	Online	Good	RAID disk	SEAGATE	9QMBKDL000099445E9C	SAS	Enabled	Disabled	Enabled	Enabled
OP	10	465	0	Online	Good	RAID disk	Seagate	3PM0HNQT	SATA2	Enabled	Disabled	Enabled	Enabled
OP	11	931	0	Online	Good	RAID disk	Seagate	9QJ1HT1P	SATA2	Enabled	Disabled	Enabled	Enabled
OP	12	1862	0	Online	Good	RAID disk	WDC	WD-WMAY00026671	SATA2	Enabled	Disabled	Enabled	Enabled

Figure 3.2.1.1

Step1: Click the “Quick installation” menu item; follow the steps to set up system name and date / time.

Quick installation

Step 1 : System setting

System name

System name : DSN-6000

Date and time

Change date and time

Current time : 2010/12/28 15:27:14

Time zone : (GMT+01:00) Brussels, Copenhagen, Madrid, Paris

Setup date and time manually

Date : 2010 / 12 / 28

Time : 15 : 27 : 8

NTP

Server :

Cancel Next >>

Figure 3.2.1.2

Step2: Confirm the management port IP address and DNS, and then click **“Next”**.

Quick installation

Step 2 : Network setting

MAC address

MAC address : 00:13:78:B0:00:D0

Address

DHCP
 Static

Address : 192.168.0.1
Mask : 255.255.255.0
Gateway : 192.168.0.254

DNS

DNS :

Port

HTTP port : 80
HTTPS port : 443
SSH port : 22

Cancel << Back Next >>

Figure 3.2.1.3

Step 3: Set up the data port IP and click **“Next”**.

Quick installation

Step 3 : iSCSI IP address

LAN1:

DHCP
 Static

Address : 192.168.1.1
Mask : 255.255.255.0
Gateway : 192.168.1.254

Cancel << Back Next >>

Figure 3.2.1.4

Step 4: Set up the RAID level and volume size and click **“Next”**.

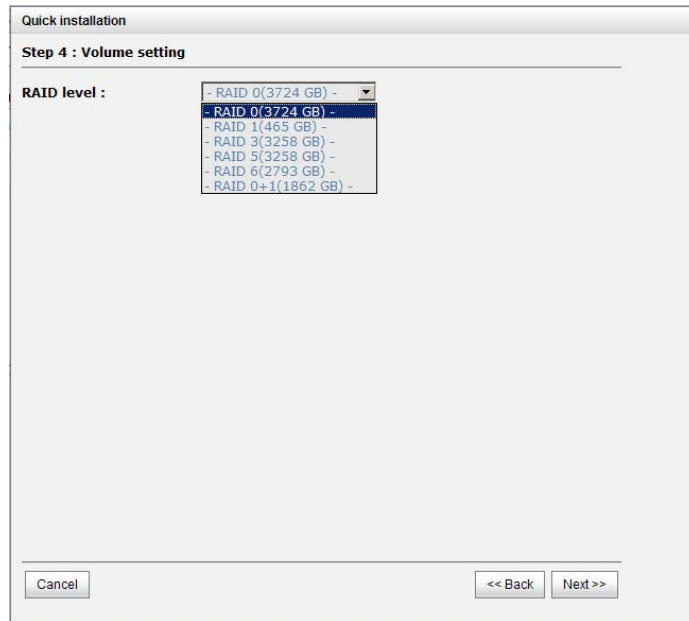

Figure 3.2.1.5

Step 5: Check all items, and click **“Finish”**.

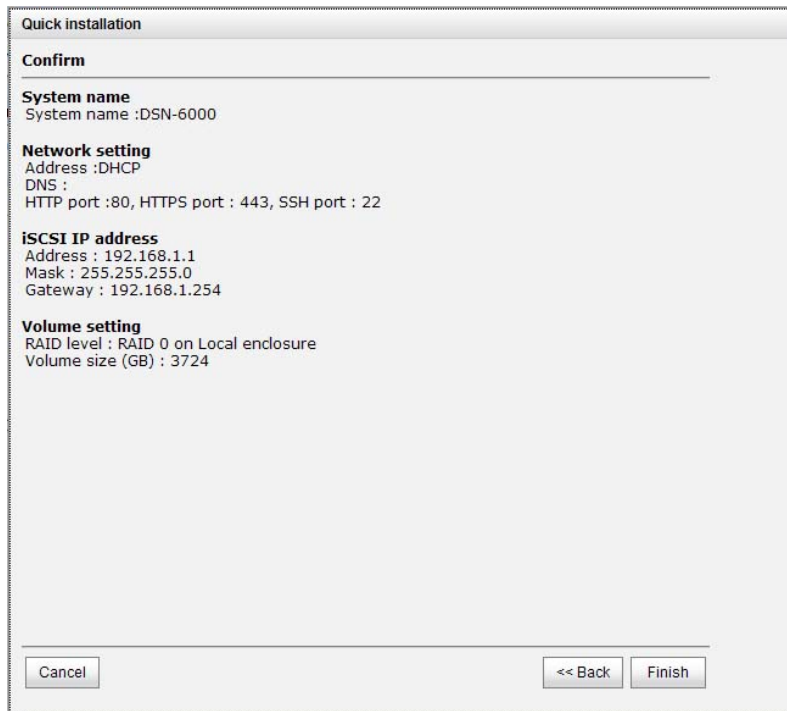

Figure 3.2.1.6

3.2.2 Volume creation wizard

“Volume create wizard” has a smarter policy. When the system is inserted with some HDDs. **“Volume create wizard”** lists all possibilities and sizes in different RAID levels, it will use all available HDDs for RAID level depends on which user chooses. When system has

different sizes of HDDs, e.g., 8*200G and 8*80G, it lists all possibilities and combination in different RAID level and different sizes. After user chooses RAID level, user may find that some HDDs are available (free status). The result is using smarter policy designed by **D-Link**. It gives user:

1. Biggest capacity of RAID level for user to choose and,
2. The fewest disk number for RAID level / volume size.

E.g., user chooses RAID 5 and the controller has 12*200G + 4*80G HDDs inserted. If we use all 16 HDDs for a RAID 5, and then the maximum size of volume is 1200G (80G*15). By the wizard, we do smarter check and find out the most efficient way of using HDDs. The wizard only uses 200G HDDs (Volume size is 200G*11=2200G), the volume size is bigger and fully uses HDD capacity.

Step 1: Select **“Volume create wizard”** and then choose the RAID level. After the RAID level is chosen, click **“Next”**.

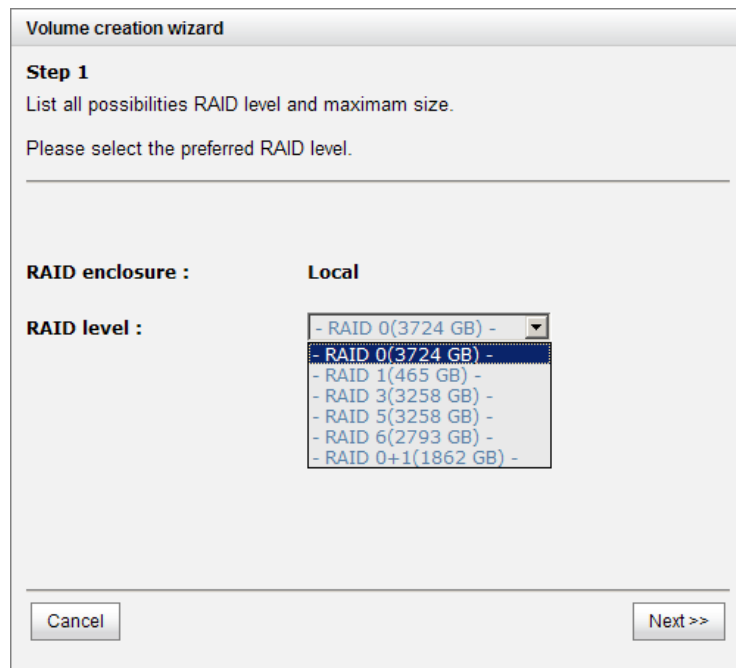

Figure 3.2.2.1

Step 2: Please select the combination of the RG capacity, or **“Use default algorithm”** for maximum RG capacity. After RG size is chosen, click **“Next”**.

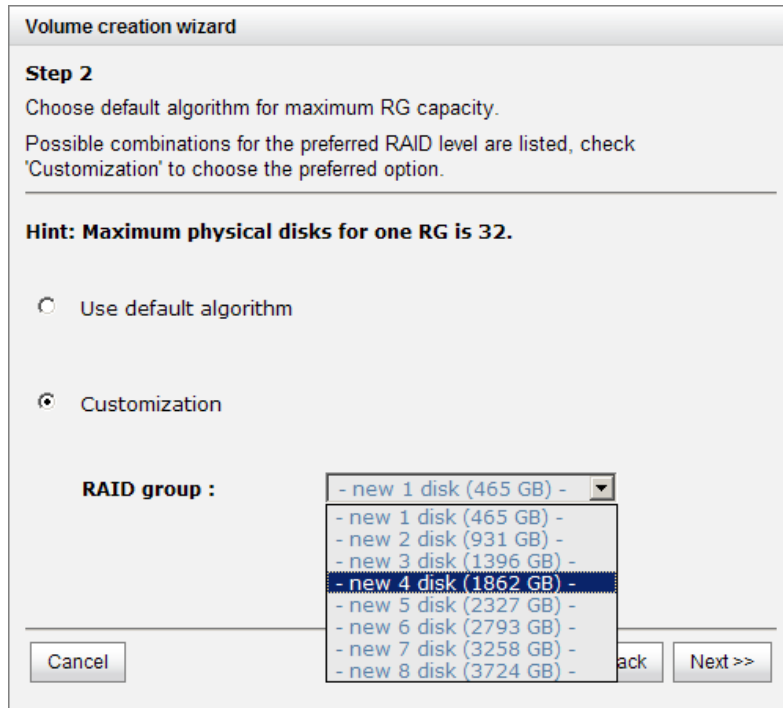

Figure 3.2.2.2

Step 3: Decide VD size. User can enter a number less or equal to the default number. Then click **“Next”**.

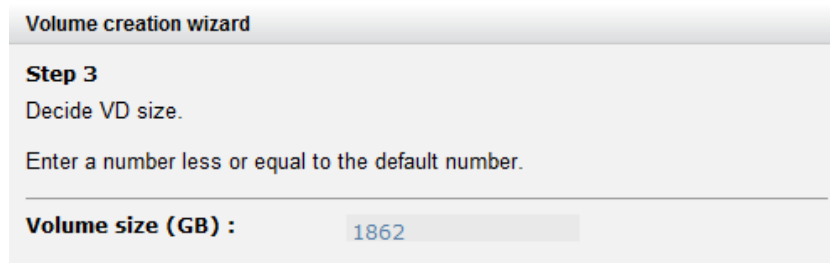

Figure 3.2.2.3

Step 4: Confirmation page. Click **“Finish”** if all setups are correct. Then a VD will be created.

Step 5: Done. The system is available now.

	Name	Size(GB)	Write	Priority	Bg rate	Type	Clone	Schedule	Status	Health	R %	RAID	#LUN	Snapshot space(GB)	#Snapshot	RG
OP	QUICK71147	1862	WB	HI	4	RAID	N/A	N/A	Online	Optimal		RAID 0	1	0/0	0	QUICK42321

Figure 3.2.2.4

(Figure 3.2.2.4: A virtual disk of RAID 0 is created and is named by system itself.)

Chapter 4 Configuration

4.1 Web UI management interface hierarchy

The below table is the hierarchy of web GUI.

System configuration

- System setting** → System name / Date and time / System indication
- Network setting** → MAC address / Address / DNS / Port
- Login setting** → Login configuration / Admin password / User password
- Mail setting** → Mail
- Notification setting** → SNMP / Messenger / System log server / Event log filter

iSCSI configuration

- NIC** → Show information for:(Controller 1/ Controller 2) Aggregation / VLAN / IP settings for iSCSI ports / Become default gateway / Enable jumbo frame / Ping host
- Entity property** → Entity name / iSNS IP
- Node** → Show information for:(Controller 1/ Controller 2) Authenticate / Change portal / Rename alias/ User
- Session** → Show information for:(Controller 1/ Controller 2) List connection / Delete
- CHAP account** → Create / Modify user information / Delete

Volume configuration

- Physical disk** → Set Free disk / Set Global spare / Set Dedicated spare / Upgrade / Disk Scrub / Turn on/off the indication LED / More information
- RAID group** → Create / Migrate / Activate / Deactivate / Parity check / Delete / Set preferred owner /Set disk property / More information
- Virtual disk** → Create / Extend / Parity check / Delete / Set property / Attach LUN / Detach LUN / List LUN / Set clone / Clear clone / Start clone / Stop clone / Schedule clone / Set snapshot space / Cleanup snapshot / Take snapshot / Auto snapshot / List snapshot / More information
- Snapshot** → Set snapshot space / Auto snapshot / Take snapshot / Export / Rollback / Delete/ Cleanup snapshot
- Logical unit** → Attach / Detach/ Session

Enclosure management

- Hardware monitor** → Controller 1 / BPL / Controller 2 / Auto shutdown
- UPS** → UPS Type / Shutdown battery level / Shutdown delay / Shutdown UPS
- SES** → Enable / Disable
- S.M.A.R.T.** → S.M.A.R.T. information (**Only for SATA hard drives**)

Maintenance

- System information** → System information
- Event log** → Download / Mute / Clear

- Upgrade** → Browse the firmware to upgrade
- Firmware synchronization** → Synchronize the slave controller's firmware version with the master's
- Reset to factory default** → Sure to reset to factory default?
- Import and export** Import/Export / Import file
- Reboot and shutdown** → Reboot / Shutdown

Quick installation

Step 1 / Step 2 / Step 3 / Step 4 / Confirm

Volume creation wizard

Step 1 / Step 2 / Step 3 / Confirm

4.2 System configuration

“System configuration” is designed for setting up the “System setting”, “Network setting”, “Login setting”, “Mail setting”, and “Notification setting”.

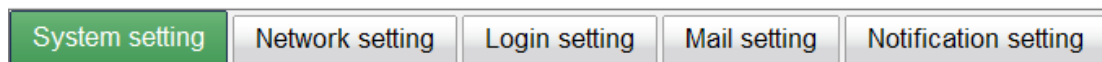

Figure 4.2.1

4.2.1 System setting

“System setting” can setup system name and date. Default “System name” is composed of model name and serial number of this system.

Figure 4.2.1.1

Check **“Change date and time”** to set up the current date, time, and time zone before using or synchronize time from NTP (Network Time Protocol) server. Click **“Confirm”** in **System indication** to turn on the system indication LED. Click again to turn off.

4.2.2 Network setting

“Network setting” is for changing IP address for remote administration usage. There are 2 options, DHCP (Get IP address from DHCP server) and static IP. The default setting is DHCP. User can change the HTTP, HTTPS, and SSH port number when the default port number is not allowed on host/server.

System setting	Network setting	Login setting	Mail setting	Notification setting
<p>Setup MAC, address, DNS and ports. You can check 'DHCP' to acquire IP address from DHCP server, or check 'Static' to setup IP address.</p>				
<p>MAC address</p> <p>MAC address : 00:13:78:BB:09:00</p>				
<p>Address</p> <p> <input checked="" type="radio"/> DHCP <input type="radio"/> BOOTP <input type="radio"/> Static </p> <p>Address : 192.168.10.82</p> <p>Mask : 255.255.255.0</p> <p>Gateway : 192.168.10.254</p>				
<p>DNS</p> <p>DNS : 192.168.10.1</p>				
<p>Port</p> <p>HTTP port : 80</p> <p>HTTPS port : 443</p> <p>SSH port : 22</p>				
<p>Confirm</p>				

Figure 4.2.2.1

4.2.3 Login setting

“Login setting” can set single admin, auto logout time and admin / user password. The single admin is to prevent multiple users access the same system in the same time.

1. **Auto logout:** The options are (1) Disabled; (2) 5 minutes; (3) 30 minutes; (4) 1 hour. The system will log out automatically when user is inactive for a period of time.
2. **Login lock:** Disabled or Enabled. When the login lock is enabled, the system allows only one user to login or modify system settings.

System setting	Network setting	Login setting	Mail setting	Notification setting
----------------	-----------------	----------------------	--------------	----------------------

Setup Login configuration and password.
If Auto logout time is set, the system will log out automatically when user is inactive for a period of time. When the login lock is enabled, the system allows only one user to login or modify system settings.

Login configuration

Auto logout :

Login lock :

Admin password

Change admin password

Old password :

Password :

Confirm :

User password

Change user password

Password :

Confirm :

Figure 4.2.3.1

Check **“Change admin password”** or **“Change user password”** to change admin or user password. The maximum length of password is 12 characters.

4.2.4 Mail setting

“Mail setting” can enter 3 mail addresses for receiving the event notification. Some mail servers would check **“Mail-from address”** and need authentication for anti-spam. Please fill the necessary fields and click **“Send test mail”** to test whether email functions are available. User can also select which levels of event logs are needed to be sent via Mail. Default setting only enables ERROR and WARNING event logs. Please also make sure the DNS server IP is well-setup so the event notification mails can be sent successfully.

System setting	Network setting	Login setting	Mail setting	Notification setting
----------------	-----------------	---------------	---------------------	----------------------

Enter at most 3 mail addresses for receiving the event notification. Some mail servers would check 'Mail-from address' and need authentication for anti-spam. After information is set, you can click 'Send test mail' to test whether email functions are available.

Mail

Mail-from address :

Mail-to address 1 :

Send events1 : INFO WARNING ERROR

Mail-to address 2 :

Send events2 : INFO WARNING ERROR

Mail-to address 3 :

Send events3 : INFO WARNING ERROR

SMTP relay ▾

SMTP server :

Authentication : ▾

Account :

Password :

Confirm :

Figure 4.2.4.1

4.2.5 Notification setting

“**Notification setting**” can set up SNMP trap for alerting via SNMP, pop-up message via Windows messenger (not MSN), alert via syslog protocol, and event log filter for web UI.

System setting	Network setting	Login setting	Mail setting	Notification setting
SNMP ▾				
SNMP trap address 1 :		<input type="text"/>		
SNMP trap address 2 :		<input type="text"/>		
SNMP trap address 3 :		<input type="text"/>		
Community :		<input type="text" value="public"/>		
MIB file download :		<input type="button" value="Download"/>		
Send events :		<input type="checkbox"/> INFO <input checked="" type="checkbox"/> WARNING <input checked="" type="checkbox"/> ERROR		
Messenger ▾				
Messenger IP/Computer name 1 :		<input type="text" value="192.168.8.241"/>		
Messenger IP/Computer name 2 :		<input type="text" value="Robert-Lin"/>		
Messenger IP/Computer name 3 :		<input type="text"/>		
Send events :		<input type="checkbox"/> INFO <input checked="" type="checkbox"/> WARNING <input checked="" type="checkbox"/> ERROR		
System log server ▾				
Server IP/hostname :		<input type="text"/>		
UDP Port :		<input type="text" value="514"/>		
Facility :		<input type="text" value="User"/>		
Event level :		<input type="checkbox"/> INFO <input checked="" type="checkbox"/> WARNING <input checked="" type="checkbox"/> ERROR		
Event log filter ▾				
Pop up events :		<input type="checkbox"/> INFO <input type="checkbox"/> WARNING <input type="checkbox"/> ERROR		
Show on LCM :		<input type="checkbox"/> INFO <input checked="" type="checkbox"/> WARNING <input checked="" type="checkbox"/> ERROR		
Buzzer ▾				
Always disable buzzer :		<input checked="" type="checkbox"/>		
<input type="button" value="Confirm"/>				

Figure 4.2.5.1

“**SNMP**” allows up to 3 SNMP trap addresses. Default community setting is “public”. User can choose the event log levels and default setting enables ERROR and WARNING event log in SNMP. There are many SNMP tools. The following web sites are for your reference:

SNMPC: <http://www.snmpc.com/>

Net-SNMP: <http://net-snmp.sourceforge.net/>

If necessary, click “**Download**” to get MIB file and import to SNMP.

To use “**Messenger**”, user must enable the service “Messenger” in Windows (Start → Control Panel → Administrative Tools → Services → Messenger), and then event logs can be received. It allows up to 3 messenger addresses. User can choose the event log levels and default setting enables the WARNING and ERROR event logs.

Using “**System log server**”, user can choose the facility and the event log level. The default port of syslog is 514. The default setting enables event level: INFO, WARNING and ERROR event logs.

There are some syslog server tools. The following web sites are for your reference:

WinSyslog: <http://www.winsyslog.com/>

Kiwi Syslog Daemon: <http://www.kiwisyslog.com/>

Most UNIX systems build in syslog daemon.

“Event log filter” setting can enable event log display on “Pop up events”.

4.3 iSCSI configuration

“iSCSI configuration” is designed for setting up the “Entity Property”, “NIC”, “Node”, “Session”, and “CHAP account”.

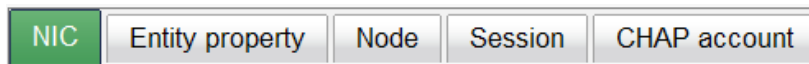

Figure 4.3.1

4.3.1 NIC

“NIC” can change IP addresses of iSCSI data ports. **DSN-6110/6120** has four gigabit ports on each controller to transmit data. Each of them must be assigned to an IP address and be set up in multi-homed mode, or the link aggregation / trunking mode has been set up. When there are multiple data ports setting up in link aggregation or trunking mode, all the data ports share single address.

NIC Entity property Node Session CHAP account											
Show information for: Controller 2											
	Name	LAG	LAG No	VLAN ID	DHCP	IP address	Netmask	Gateway	Jumbo frame	MAC address	Link
<input type="button" value="OP."/>	LAN1	No	N/A	N/A	No	192.168.11.5	255.255.255.0		Disabled	00:13:78:bb:09:0c	Up
<input type="button" value="OP."/>	LAN2	No	N/A	N/A	No	192.168.12.6	255.255.255.0		Disabled	00:13:78:bb:09:0d	Up
<input type="button" value="OP."/>	LAN3	No	N/A	N/A	No	192.168.11.7	255.255.255.0		Disabled	00:13:78:bb:09:0e	Up
<input type="button" value="OP."/>	LAN4	No	N/A	N/A	No	192.168.12.8	255.255.255.0		Disabled	00:13:78:bb:09:0f	Up

Aggregation

Figure 4.3.1.1

(Figure 4.3.1.1: There are 4 iSCSI data ports on each controller. 4 data ports are set with static IP.)

- IP settings:

User can change IP address by checking the gray button of LAN port, click “IP settings for iSCSI ports”. There are 2 selections, DHCP (Get IP address from DHCP server) or static IP.

Figure 4.3.1.2

- **Default gateway:**

Default gateway can be changed by checking the gray button of LAN port, click “**Become default gateway**”. There can be only one default gateway.

- **MTU / Jumbo frame:**

MTU (Maximum Transmission Unit) size can be enabled by checking the gray button of LAN port, click “**Enable jumbo frame**”. Maximum jumbo frame size is **3900** bytes.



Caution

The MTU size of switching hub and HBA on host must be enabled. Otherwise, the LAN connection can not work properly.

- **Multi-homed / Trunking / LACP:**

The following is the description of multi-homed / trunking / LACP functions.

1. **Multi-homed:** Default mode. Each of iSCSI data port is connected by itself and is not link aggregation and trunking. This function is also for Multipath functions. Select this mode can also remove the setting of Trunking / LACP in same time.
2. **Trunking:** defines the use of multiple iSCSI data ports in parallel to increase the link speed beyond the limits of any single port.
3. **LACP:** The Link Aggregation Control Protocol (LACP) is part of IEEE specification 802.3ad that allows bundling several physical ports together to form a single logical channel. LACP allows a network switch to negotiate an automatic bundle by sending

LACP packets to the peer. The advantages of LACP are (1) increases the bandwidth. (2) failover when link status fails on a port.

Trunking / LACP setting can be changed by clicking the button **“Aggregation”**.

Figure 4.3.1.3

(Figure 4.3.1.3: There are 4 iSCSI data ports on each controller, select at least two NICs for link aggregation.)

NIC											
Entity property											
Node											
Session											
CHAP account											
Show information for: Controller 2											
	Name	LAG	LAG No	VLAN ID	DHCP	IP address	Netmask	Gateway	Jumbo frame	MAC address	Link
OP.	LAN1	Trunking	0	N/A	No	192.168.11.5	255.255.255.0		Disabled	00:13:78:bb:09:0c	Up
OP.	LAN2	Trunking	0	N/A	No	192.168.11.5	255.255.255.0		Disabled	00:13:78:bb:09:0c	Up
OP.	LAN3	LACP	1	N/A	No	192.168.11.7	255.255.255.0		Disabled	00:13:78:bb:09:0e	Down
OP.	LAN4	LACP	1	N/A	No	192.168.11.7	255.255.255.0		Disabled	00:13:78:bb:09:0e	Down

Delete link aggregation

Link aggregation or Multi-homed

Set VLAN ID

IP settings for iSCSI ports

Become default gateway

Enable jumbo frame

Ping host

Enable Replication

Figure 4.3.1.4

For example, LAN1 and LAN2 are set as Trunking mode. LAN3 and LAN4 are set as LACP mode. To remove Trunking / LACP setting, check the gray button of LAN port, click **“Delete link aggregation”**. Then it will pop up a message to confirm.

- **Ping host:**

User can ping the corresponding host data port from the target, click **“Ping host”**.

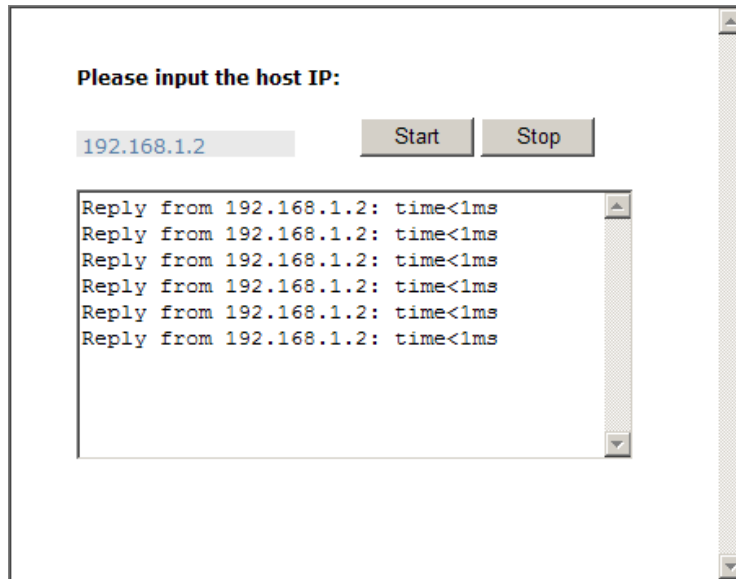

Figure 4.3.1.5

(Figure 4.3.1.5 shows a user can ping host from the target to make sure the data port connection is well.)

4.3.2 Entity property

“Entity property” can view the entity name of the system, and setup “iSNS IP” for iSNS (Internet Storage Name Service). iSNS protocol allows automated discovery, management and configuration of [iSCSI](#) devices on a [TCP/IP](#) network. Using iSNS, it needs to install an iSNS server in SAN. Add an iSNS server IP address into iSNS server lists in order that iSCSI initiator service can send queries. The entity name can be changed.

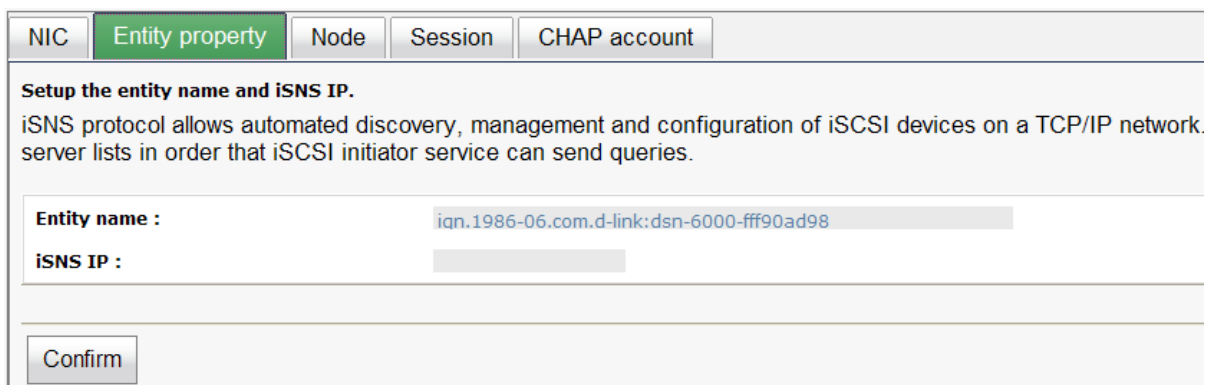

Figure 4.3.2.1

4.3.3 Node

“Node” can view the target name for iSCSI initiator. **DSN-6110/6120** supports up to 32 multi-nodes. There are 32 default nodes created for each controller.

NIC		Entity property		Node	Session	CHAP account
Show information for: Controller 1						
<< first < prev 1 2 3 next > last >>						
	ID	Auth	Name	Portal	Alias	
<input type="button" value="OP."/>	0	None	iqn.1986-06.com.d-link:dsn-6000-fff90ad98:dev0.ctr1	192.168.1.1:3260, 192.168.2.1:3260, 0.0.0.0:3260, 192.168.4.1:3260		
<input type="button" value="OP."/>	1	None	iqn.1986-06.com.d-link:dsn-6000-fff90ad98:dev1.ctr1	192.168.1.1:3260, 192.168.2.1:3260, 0.0.0.0:3260, 192.168.4.1:3260		
<input type="button" value="OP."/>	2	None	iqn.1986-06.com.d-link:dsn-6000-fff90ad98:dev2.ctr1	192.168.1.1:3260, 192.168.2.1:3260, 0.0.0.0:3260, 192.168.4.1:3260		
<input type="button" value="OP."/>	3	None	iqn.1986-06.com.d-link:dsn-6000-fff90ad98:dev3.ctr1	192.168.1.1:3260, 192.168.2.1:3260, 0.0.0.0:3260, 192.168.4.1:3260		
<input type="button" value="OP."/>	4	None	iqn.1986-06.com.d-link:dsn-6000-fff90ad98:dev4.ctr1	192.168.1.1:3260, 192.168.2.1:3260, 0.0.0.0:3260, 192.168.4.1:3260		
<input type="button" value="OP."/>	5	None	iqn.1986-06.com.d-link:dsn-6000-fff90ad98:dev5.ctr1	192.168.1.1:3260, 192.168.2.1:3260, 0.0.0.0:3260, 192.168.4.1:3260		
<input type="button" value="OP."/>	6	None	iqn.1986-06.com.d-link:dsn-6000-fff90ad98:dev6.ctr1	192.168.1.1:3260, 192.168.2.1:3260, 0.0.0.0:3260, 192.168.4.1:3260		
<input type="button" value="OP."/>	7	None	iqn.1986-06.com.d-link:dsn-6000-fff90ad98:dev7.ctr1	192.168.1.1:3260, 192.168.2.1:3260, 0.0.0.0:3260, 192.168.4.1:3260		
<input type="button" value="OP."/>	8	None	iqn.1986-06.com.d-link:dsn-6000-fff90ad98:dev8.ctr1	192.168.1.1:3260, 192.168.2.1:3260, 0.0.0.0:3260, 192.168.4.1:3260		
<input type="button" value="OP."/>	9	None	iqn.1986-06.com.d-link:dsn-6000-fff90ad98:dev9.ctr1	192.168.1.1:3260, 192.168.2.1:3260, 0.0.0.0:3260, 192.168.4.1:3260		
<input type="button" value="OP."/>	10	None	iqn.1986-06.com.d-link:dsn-6000-fff90ad98:dev10.ctr1	192.168.1.1:3260, 192.168.2.1:3260, 0.0.0.0:3260, 192.168.4.1:3260		
<input type="button" value="OP."/>	11	None	iqn.1986-06.com.d-link:dsn-6000-fff90ad98:dev11.ctr1	192.168.1.1:3260, 192.168.2.1:3260, 0.0.0.0:3260, 192.168.4.1:3260		

Figure 4.3.3.1

- **CHAP:**

CHAP is the abbreviation of **C**hallenge **H**andshake **A**uthentication **P**rotocol. CHAP is a strong authentication method used in point-to-point for user login. It's a type of authentication in which the authentication server sends the client a key to be used for encrypting the username and password. CHAP enables the username and password to transmit in an encrypted form for protection.

To use CHAP authentication, please follow the procedures.

1. Select one of 32 default nodes from one controller.
2. Check the gray button of "OP.", click "Authenticate".
3. Select "CHAP".

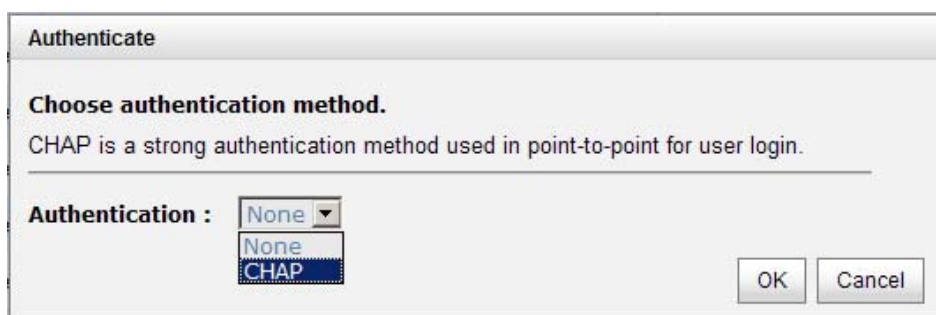

Figure 4.3.3.2

4. Click "OK".

	ID	Auth	Name	Portal	Alias
<input type="button" value="OP."/>	0	CHAP	iqn.1986-06.com.d-link:dsn-6000-fff90ad98:dev0.ctr1	192.168.1.1:3260, 192.168.2.1:3260, 0.0.0.0:3260, 192.168.4.1:3260	
<input type="button" value="OP."/>	1	CHAP	iqn.1986-06.com.d-link:dsn-6000-fff90ad98:dev1.ctr1	192.168.1.1:3260, 192.168.2.1:3260, 0.0.0.0:3260, 192.168.4.1:3260	
<input type="button" value="OP."/>	2	None	iqn.1986-06.com.d-link:dsn-6000-fff90ad98:dev2.ctr1	192.168.1.1:3260, 192.168.2.1:3260, 0.0.0.0:3260, 192.168.4.1:3260	
<input type="button" value="OP."/>	3	None	iqn.1986-06.com.d-link:dsn-6000-fff90ad98:dev3.ctr1	192.168.1.1:3260, 192.168.2.1:3260, 0.0.0.0:3260, 192.168.4.1:3260	

Figure 4.3.3.3

5. Go to **"/ iSCSI configuration / CHAP account"** page to create CHAP account. Please refer to next section for more detail.
6. Check the gray button of **"OP."** column, click **"User"**.
7. Select CHAP user(s) which will be used. It's a multi option; it can be one or more. If choosing none, CHAP can not work.

Figure 4.3.3.4

8. Click **"OK"**.
9. In **"Authenticate"** of **"OP"** page, select **"None"** to disable CHAP.

- **Change portal:**

Users can change the portals belonging to the device node of each controller.

1. Check the gray button of **"OP."** column next to one device node.
2. Select **"Change portal"**.
3. Choose the portals for the controller.
4. Click **"OK"** to confirm.

Figure 4.3.3.5

- **Rename alias:**

User can create an alias to one device node.

1. Check the gray button of **"OP."** column next to one device node.
2. Select **"Rename alias"**.
3. Create an alias for that device node.
4. Click **"OK"** to confirm.
5. An alias appears at the end of that device node.

Figure 4.3.3.6

	ID	Auth	Name	Portal	Alias
<input type="button" value="OP."/>	0	CHAP	iqn.1986-06.com.d-link:dsn-6000-fff90ad98:dev0.ctr1	192.168.1.1:3260, 192.168.2.1:3260, 192.168.1.1:3260, 192.168.4.1:3260	dev0.ctr1
<input type="button" value="OP."/>	1	CHAP	iqn.1986-06.com.d-link:dsn-6000-fff90ad98:dev1.ctr1	192.168.1.1:3260, 192.168.2.1:3260, 192.168.1.1:3260, 192.168.4.1:3260	
<input type="button" value="OP."/>	2	None	iqn.1986-06.com.d-link:dsn-6000-fff90ad98:dev2.ctr1	192.168.1.1:3260, 192.168.2.1:3260, 192.168.1.1:3260, 192.168.4.1:3260	
<input type="button" value="OP."/>	3	None	iqn.1986-06.com.d-link:dsn-6000-fff90ad98:dev3.ctr1	192.168.1.1:3260, 192.168.2.1:3260, 192.168.1.1:3260, 192.168.4.1:3260	

Figure 4.3.3.7



Tips

After setting CHAP, the initiator in host should be set with the same CHAP account. Otherwise, user cannot login.

4.3.4 Session

"Session" can display current iSCSI session and connection information, including the following items:

1. TSIH (target session identifying handle)
2. Host (Initiator Name)
3. Controller (Target Name)
4. InitialR2T(Initial Ready to Transfer)
5. Immed. data(Immediate data)
6. MaxDataOutR2T(Maximum Data Outstanding Ready to Transfer)
7. MaxDataBurstLen(Maximum Data Burst Length)
8. DataSeeginOrder(Data Sequence in Order)
9. DataPDUInOrder(Data PDU in Order)
10. Detail of Authentication status and Source IP: port number.

NIC	Entity property	Node	Session	CHAP account
-----	-----------------	------	---------	--------------

Display iSCSI session and connection information, including other items.

Show information for: Controller 2

No.	TSIH	Initiator name	Target name	InitialR2T	Immed. data	MaxOutR2T	MaxDataBurstLen	DataSeqInOrder	DataPDUInOrder
OP: 0	0x0001	e6	d-link:dsn-6000:dev0.ctr2	Yes	Yes	1	262144	Yes	Yes

Figure 4.3.4.1 (iSCSI Session)

Check the gray button of session number, click **“List connection”**. It can list all connection(s) of the session.

No.	Initiator IP	Initiator name	MaxRecvDataSegLen	MaxTransDataSegLen	Authentication
1	192.168.11.77	e6	16384	65536	No

OK

Figure 4.3.4.2 (iSCSI Connection)

4.3.5 CHAP account

“CHAP account” can manage a CHAP account for authentication. **DSN-6110/6120** can create multiple CHAP accounts.

To setup CHAP account, please follow the procedures.

1. Click **“Create”**.
2. Enter **“User”**, **“Secret”**, and **“Confirm”** secret again. **“Node”** can be selected here or later. If selecting none, it can be enabled later in **“/ iSCSI configuration / Node / User”**.

Create

Create a CHAP user

To create a CHAP user account, enter 'User', 'Secret', and 'Confirm' secret. One or multiple nodes can be selected here or later. If selecting none, it can be enabled in '/ iSCSI configuration / Node / User'.

User : DLink (max: 223)

Secret : (min: 12, max: 16)

Confirm : (min: 12, max: 16)

Node : 0
1
2
3
4
5
6
7
8
9

OK Cancel

Figure 4.3.5.1

3. Click **“OK”**.

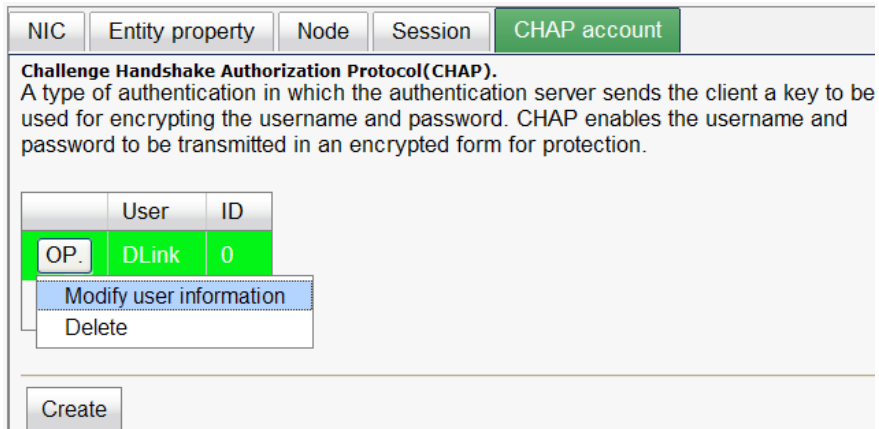

Figure 4.3.5.2

4. Click **“Delete”** to delete CHAP account.

4.4 Volume configuration

“Volume configuration” is designed for setting up the volume configuration which includes **“Physical disk”**, **“RAID group”**, **“Virtual disk”**, **“Snapshot”**, **“Logical unit”**, and **“Replication”** (optional).

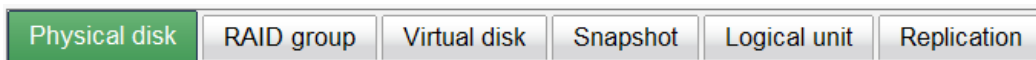

Figure 4.4.1

4.4.1 Physical disk

“Physical disk” can view the status of hard drives in the system. The followings are operational steps:

1. Check the gray button next to the number of slot, it will show the functions which can be executed.
2. Active function can be selected, and inactive functions show up in gray color and cannot be selected.

For example, set PD slot number 4 to dedicated spare disk.

Step 1: Check to the gray button of PD 4, select **“Set Dedicated spare”**, it will link to next page.

Show PD for: Local Show size unit as: GB

	Slot	Size(GB)	RG	Status	Health	Usage	Vendor	Serial	Type	Write cache	Standby	Readahead	Command queuing
OP	1	465	RG-R5	Online	Good	RAID disk	SEAGATE	3QM00X1W00009843LV6Z	SAS	Enabled	Disabled	Enabled	Enabled
OP	2	465	RG-R5	Online	Good	RAID disk	SEAGATE	9QMBKDSX000099445E69	SAS	Enabled	Disabled	Enabled	Enabled
OP	3	465	RG-R5	Online	Good	RAID disk	SEAGATE	9QMBKV6R00009942TKPJ	SAS	Enabled	Disabled	Enabled	Enabled
OP	4	465		Online	Good	Free disk	SEAGATE	9QMBKE2W000099445C09	SAS	Enabled	Disabled	Enabled	Enabled
				Online	Good	Free disk	SEAGATE	9QMBKE81000099445DVM	SAS	Enabled	Disabled	Enabled	Enabled
				Online	Good	Free disk	SEAGATE	9QM4AFLD00009845WFC9	SAS	Enabled	Disabled	Enabled	Enabled
				Online	Good	Free disk	SEAGATE	9QMBWLL900009003YYHD	SAS	Enabled	Disabled	Enabled	Enabled
				Online	Good	Free disk	SEAGATE	9QMBKDP000099445B7N	SAS	Enabled	Disabled	Enabled	Enabled

- Set Free disk
- Set Global spare
- Set Dedicated spare
- Upgrade
- Disk Scrub
- Turn on the indication LED
- More information

Figure 4.4.1.1

Step 2: If there is any RG which is in protected RAID level and can be set with dedicate spare disk, select one RG, and then click **“Submit”**.

Set Dedicated spare

	No.	Name	Total	Free	#PD	#VD	Status	Health	RAID
<input checked="" type="radio"/>	1	RG-R5	931	931	3	0	Online	Good	RAID 5

Figure 4.4.1.2

Step 3: Done. View **“Physical disk”** page.

Show PD for: Local Show size unit as: GB

	Slot	Size(GB)	RG	Status	Health	Usage	Vendor	Serial	Type	Write cache	Standby	Readahead	Command queuing
OP	1	465	RG-R5	Online	Good	RAID disk	SEAGATE	3QM00X1W00009843LV6Z	SAS	Enabled	Disabled	Enabled	Enabled
OP	2	465	RG-R5	Online	Good	RAID disk	SEAGATE	9QMBKDSX000099445E69	SAS	Enabled	Disabled	Enabled	Enabled
OP	3	465	RG-R5	Online	Good	RAID disk	SEAGATE	9QMBKV6R00009942TKPJ	SAS	Enabled	Disabled	Enabled	Enabled
OP	4	465	RG-R5	Online	Good	Dedicated spare	SEAGATE	9QMBKE2W000099445C09	SAS	Enabled	Disabled	Enabled	Enabled
OP	5	465		Online	Good	Free disk	SEAGATE	9QMBKE81000099445DVM	SAS	Enabled	Disabled	Enabled	Enabled
OP	6	465		Online	Good	Free disk	SEAGATE	9QM4AFLD00009845WFC9	SAS	Enabled	Disabled	Enabled	Enabled
OP	7	465		Online	Good	Free disk	SEAGATE	9QMBWLL900009003YYHD	SAS	Enabled	Disabled	Enabled	Enabled
OP	8	465		Online	Good	Free disk	SEAGATE	9QMBKDP000099445B7N	SAS	Enabled	Disabled	Enabled	Enabled

Figure 4.4.1.3

(Figure 4.4.1.3: Physical disks in slot 1,2,3 are created for a RG named **“RG-R5”**. Slot 4 is set as dedicated spare disk of the RG named **“RG-R5”**. The others are free disks.)

Step 4: The unit of size can be changed from (GB) to (MB). It will display the capacity of hard drive in MB.

Show PD for: Show size unit as:

	Slot	Size(MB)	RG	Status	Health	Usage
<input type="button" value="OP"/>	1	476684	RG-R5	Online	Good	RAID disk
<input type="button" value="OP"/>	2	476684	RG-R5	Online	Good	RAID disk
<input type="button" value="OP"/>	3	476684	RG-R5	Online	Good	RAID disk
<input type="button" value="OP"/>	4	476684	RG-R5	Online	Good	Dedicated spare
<input type="button" value="OP"/>	5	476684		Online	Good	Free disk
<input type="button" value="OP"/>	6	476684		Online	Good	Free disk
<input type="button" value="OP"/>	7	476684		Online	Good	Free disk
<input type="button" value="OP"/>	8	476684		Online	Good	Free disk

Figure 4.4.1.4

• PD column description:

Slot	The position of a hard drive. The button next to the number of slot shows the functions which can be executed.
Size (GB) (MB)	Capacity of hard drive. The unit can be displayed in GB or MB.
RG Name	RAID group name.
Status	The status of hard drive: <ul style="list-style-type: none"> • "Online" → the hard drive is online. • "Rebuilding" → the hard drive is being rebuilt. • "Transition" → the hard drive is being migrated or is replaced by another disk when rebuilding occurs. • "Scrubbing" → the hard drive is being scrubbed.
Health	The health of hard drive: <ul style="list-style-type: none"> • "Good" → the hard drive is good. • "Failed" → the hard drive is failed. • "Error Alert" → S.M.A.R.T. error alert. • "Read Errors" → the hard drive has unrecoverable read errors.
Usage	The usage of hard drive: <ul style="list-style-type: none"> • "RAID disk" → This hard drive has been set to a

	<p>RAID group.</p> <ul style="list-style-type: none"> • "Free disk" → This hard drive is free for use. • "Dedicated spare" → This hard drive has been set as dedicated spare of a RG. • "Global spare" → This hard drive has been set as global spare of all RGs.
Vendor	Hard drive vendor.
Serial	Hard drive serial number.
Type	<p>Hard drive type:</p> <ul style="list-style-type: none"> • "SATA" → SATA disk. • "SATA2" → SATA II disk. • "SAS" → SAS disk.
Write cache	Hard drive write cache is enabled or disabled. Default is "Enabled" .
Standby	HDD auto spindown to save power. Default is "Disabled" .
Readahead	This feature makes data be loaded to disk's buffer in advance for further use. Default is "Enabled" .
Command queuing	Newer SATA and most SCSI disks can queue multiple commands and handle one by one. Default is "Enabled" .

- **PD operation description:**

Set Free disk	Make the selected hard drive be free for use.
Set Global spare	Set the selected hard drive to global spare of all RGs.
Set Dedicated spares	Set a hard drive to dedicated spare of the selected RG.
Upgrade	Upgrade hard drive firmware.
Disk Scrub	Scrub the hard drive.
Turn on/off	Turn on the indication LED of the hard drive. Click again to turn

the indication LED	off.
More information	Show hard drive detail information.

4.4.2 RAID group

“RAID group” can view the status of each RAID group, create, and modify RAID groups. The following is an example to create a RG.

Step 1: Click “Create”, enter “Name”, choose “RAID level”, click “Select PD” to select PD, assign the RG’s “Preferred owner”. Then click “OK”. The “Write Cache” option is to enable or disable the write cache option of hard drives. The “Standby” option is to enable or disable the auto spindown function of hard drives, when this option is enabled and hard drives have no I/O access after certain period of time, they will spin down automatically. The “Readahead” option is to enable or disable the read ahead function. The “Command queuing” option is to enable or disable the hard drives’ command queue function.

Figure 4.4.2.1

Step 2: Confirm page. Click “OK” if all setups are correct.

Show size unit as: (GB) ▾

	Name	Total(GB)	Free(GB)	#PD	#VD	Status	Health	RAID	Current owner	Preferred owner
OP.	RG-R0	1862	1862	4	0	Online	Good	RAID 0	Controller 1	Controller 1
OP.	RG-R5	931	931	3	0	Online	Good	RAID 5	Controller 1	Controller 1

Migrate
 Activate
 Deactivate
 Parity check
 Delete
 Set preferred owner
 Set disk property
 More information

Figure 4.4.2.2

(Figure 4.4.2.2: There is a RAID 0 with 4 physical disks, named "RG-R0". The second RAID group is a RAID 5 with 3 physical disks, named "RG-R5".)

Step 3: Done. View "RAID group" page.

- **RG column description:**

	The button includes the functions which can be executed.
Name	RAID group name.
Total (GB) (MB)	Total capacity of this RAID group. The unit can be displayed in GB or MB.
Free (GB) (MB)	Free capacity of this RAID group. The unit can be displayed in GB or MB.
#PD	The number of physical disks in a RAID group.
#VD	The number of virtual disks in a RAID group.
Status	The status of RAID group: <ul style="list-style-type: none"> • "Online" → the RAID group is online. • "Offline" → the RAID group is offline. • "Rebuild" → the RAID group is being rebuilt. • "Migrate" → the RAID group is being migrated. • "Scrubbing" → the RAID group is being scrubbed.
Health	The health of RAID group: <ul style="list-style-type: none"> • "Good" → the RAID group is good.

	<ul style="list-style-type: none"> • “Failed” → the RAID group fails. • “Degraded” → the RAID group is not healthy and not completed. The reason could be lack of disk(s) or have failed disk
RAID	The RAID level of the RAID group.
Current owner	The owner of the RAID group. The default owner is controller 1.
Preferred owner	The preferred owner of the RAID group. The default owner is controller 1.

- **RG operation description:**

Create	Create a RAID group.
Migrate	Change the RAID level of a RAID group. Please refer to next chapter for details.
Activate	Activate the RAID group after disk roaming; it can be executed when RG status is offline. This is for online disk roaming purpose.
Deactivate	Deactivate the RAID group before disk roaming; it can be executed when RG status is online. This is for online disk roaming purpose.
Parity check	Regenerate parity for the RAID group. It supports RAID 3 / 5 / 6 / 30 / 50 / 60.
Delete	Delete the RAID group.
Set preferred owner	Set the RG ownership to the other controller.
Set disk property	<p>Change the disk property of write cache and standby options.</p> <p>Write cache:</p> <p> “Enabled” → Enable disk write cache. (Default)</p> <p> “Disabled” → Disable disk write cache.</p> <p>Standby:</p> <p> “Disabled” → Disable auto spindown. (Default)</p> <p> “30 sec / 1 min / 5 min / 30 min” → Enable hard drive auto spindown to save power when no access after certain period of time.</p> <p>Read ahead:</p> <p> “Enabled” → Enable disk read ahead. (Default)</p> <p> “Disabled” → Disable disk read ahead.</p>

	Command queuing: "Enabled" → Enable disk command queue. (Default) "Disabled" → Disable disk command queue.
More information	Show RAID group detail information.

4.4.3 Virtual disk

"Virtual disk" can view the status of each Virtual disk, create, and modify virtual disks. The following is an example to create a VD.

Step 1: Click **"Create"**, enter **"Name"**, select RAID group from **"RG name"**, enter required **"Capacity (GB)/(MB)"**, change **"Stripe height (KB)"**, change **"Block size (B)"**, change **"Read/Write"** mode, set virtual disk **"Priority"**, select **"Bg rate"** (Background task priority), and change **"Readahead"** option if necessary. **"Erase"** option will wipe out old data in VD to prevent that OS recognizes the old partition. There are three options in "Erase": None (default), erase first 1GB or full disk. Last, select **"Type"** mode for normal or clone usage. Then click **"OK"**.

Figure 4.4.3.1



Caution

If shutdown or reboot the system when creating VD, the erase process will stop.

Step 2: Confirm page. Click **“OK”** if all setups are correct.

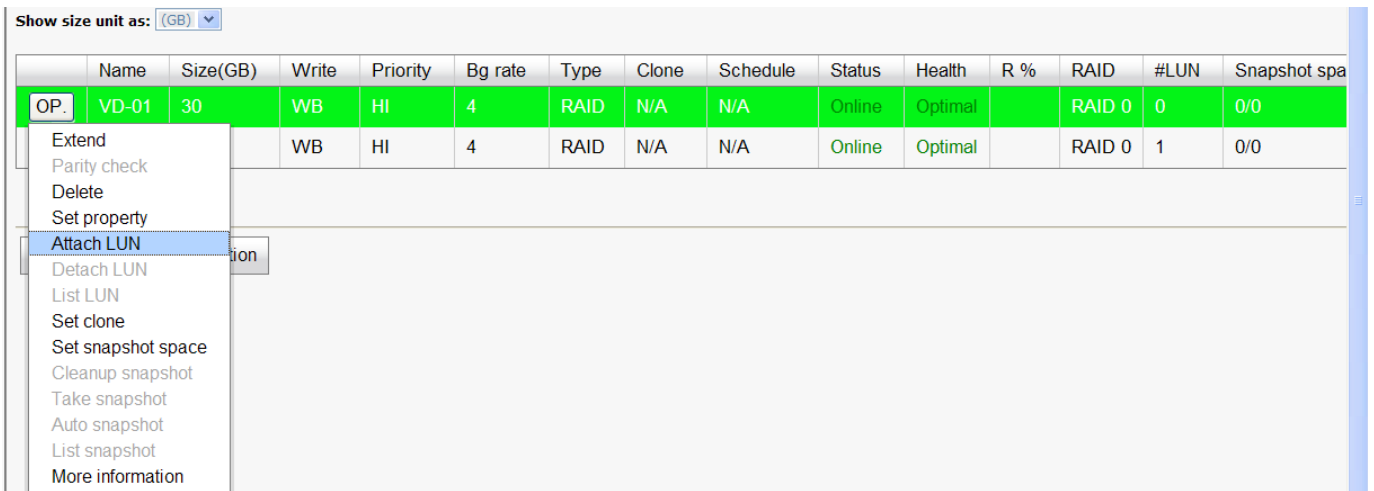

Figure 4.4.3.2

(Figure 4.4.3.2: Create a VD named “VD-01”, from “RG-R0”.)

Step 3: Done. View **“Virtual disk”** page.

- **VD column description:**

	The button includes the functions which can be executed.
Name	Virtual disk name.
Size (GB) (MB)	Total capacity of the virtual disk. The unit can be displayed in GB or MB.
Write	The right of virtual disk: <ul style="list-style-type: none"> • “WT” → Write Through. • “WB” → Write Back. • “RO” → Read Only.
Priority	The priority of virtual disk: <ul style="list-style-type: none"> • “HI” → High priority. • “MD” → MiDdle priority. • “LO” → Low priority.
Bg rate	Background task priority: <ul style="list-style-type: none"> • “4 / 3 / 2 / 1 / 0” → Default value is 4. The higher

	number the background priority of a VD is, the more background I/O will be scheduled to execute.
Status	<p>The status of virtual disk:</p> <ul style="list-style-type: none"> • "Online" → The virtual disk is online. • "Offline" → The virtual disk is offline. • "Initiating" → The virtual disk is being initialized. • "Rebuild" → The virtual disk is being rebuilt. • "Migrate" → The virtual disk is being migrated. • "Rollback" → The virtual disk is being rolled back. • "Parity checking" → The virtual disk is being parity check.
Type	<p>The type of virtual disk:</p> <ul style="list-style-type: none"> • "RAID" → the virtual disk is normal. • "BACKUP" → the virtual disk is for clone usage.
Clone	The target name of virtual disk.
Schedule	The clone schedule of virtual disk:
Health	<p>The health of virtual disk:</p> <ul style="list-style-type: none"> • "Optimal" → the virtual disk is working well and there is no failed disk in the RG. • "Degraded" → At least one disk from the RG of the Virtual disk is failed or plugged out. • "Failed" → the RAID group disk of the VD has single or multiple failed disks than its RAID level can recover from data loss. • "Partially optimal" → the virtual disk has experienced recoverable read errors. After passing parity check, the health will become "Optimal".
R %	Ratio (%) of initializing or rebuilding.
RAID	RAID level.
#LUN	Number of LUN(s) that virtual disk is attached to.
Snapshot (GB) (MB)	The virtual disk size that is used for snapshot. The number means "Used snapshot space" / "Total snapshot space" .

	The unit can be displayed in GB or MB.
#Snapshot	Number of snapshot(s) that have been taken.
RG name	The RG name of the virtual disk

- **VD operation description:**

Create	Create a virtual disk.
Extend	Extend the virtual disk capacity.
Parity check	Execute parity check for the virtual disk. It supports RAID 3 / 5 / 6 / 30 / 50 / 60. Regenerate parity: <ul style="list-style-type: none"> • "Yes" → Regenerate RAID parity and write. • "No" → Execute parity check only and find mismatches. It will stop checking when mismatches count to 1 / 10 / 20 / ... / 100.
Delete	Delete the virtual disk.
Set property	Change the VD name, right, priority, bg rate and read ahead. Right: <ul style="list-style-type: none"> • "WT" → Write Through. • "WB" → Write Back. (Default) • "RO" → Read Only. Priority: <ul style="list-style-type: none"> • "HI" → High priority. (Default) • "MD" → MiDdle priority. • "LO" → LOw priority. Bg rate: <ul style="list-style-type: none"> • "4 / 3 / 2 / 1 / 0" → Default value is 4. The higher number the background priority of a VD is, the more background I/O will be scheduled to execute. Read ahead: <ul style="list-style-type: none"> • "Enabled" → Enable disk read ahead. (Default) • "Disabled" → Disable disk read ahead. AV-media mode: <ul style="list-style-type: none"> • "Enabled" → Enable AV-media mode for optimizing video

	<p>editing.</p> <ul style="list-style-type: none"> • “Disabled” → Disable AV-media mode. (Default) <p>Type:</p> <ul style="list-style-type: none"> • “RAID” → the virtual disk is normal. (Default) • “Backup” → the virtual disk is for clone usage.
Attach LUN	Attach to a LUN.
Detach LUN	Detach to a LUN.
List LUN	List attached LUN(s).
Set clone	Set the target virtual disk for clone.
Clear clone	Clear clone function.
Start clone	Start clone function.
Stop clone	Stop clone function.
Schedule clone	Set clone function by schedule.
Set snapshot space	Set snapshot space for taking snapshot. Please refer to next chapter for more detail.
Cleanup snapshot	Clean all snapshots of a VD and release the snapshot space.
Take snapshot	Take a snapshot on the virtual disk.
Auto snapshot	Set auto snapshot on the virtual disk.
List snapshot	List all snapshots of the virtual disk.
More information	Show virtual disk detail information.

4.4.4 Snapshot

“Snapshot” can view the status of snapshot, create, and modify snapshots. Please refer to next chapter for more detail about snapshot concept. The following is an example to take a snapshot.

Step 1: Create snapshot space. In “/ Volume configuration / Virtual disk”, Check to the gray button next to the VD number; click “Set snapshot space”.

Step 2: Set snapshot space. Then click “OK”. The snapshot space is created.

Figure 4.4.4.1

Show size unit as: (GB)

	Name	Size(GB)	Write	Priority	Bg rate	Type	Clone	Schedule	Status	Health	R %	RAID	#LUN	Snapshot space(GB)	#Snapshot	RG
OP:	VD-01	30	WB	HI	4	RAID	N/A	N/A	Online	Optimal		RAID 0	0	1/15	0	RG-R0
OP:	VD-02	20	WB	HI	4	RAID	N/A	N/A	Online	Optimal		RAID 5	0	0/0	0	RG-R5

Figure 4.4.4.2

(Figure 4.4.4.2: “VD-01” snapshot space has been created, snapshot space is 15GB, and used 1GB for saving snapshot index.)

Step 3: Take a snapshot. In “/ Volume configuration / Snapshot”, click “Take snapshot”. It will link to next page. Enter a snapshot name.

Linked snapshot for VD: - VD-R0 - Show size unit as: (GB)

	No.	Name	Used(GB)	Status	Health	Exposure	Right	#LUN	Created time
OP	1	SnapVD-01	0	N/A	Good	No	N/A	N/A	Fri Aug 20 18:02:44 2010

Expose
Rollback
Delete

Auto snapshot Take snapshot Cleanup snapshot

Figure 4.4.4.3

Step 4: Expose the snapshot VD. Check to the gray button next to the Snapshot VD number; click “Expose”. Enter a capacity for snapshot VD. If size is zero, the exposed snapshot VD will be read only. Otherwise, the exposed snapshot VD can be read / written, and the size will be the maximum capacity for read / write.



Figure 4.4.4.4

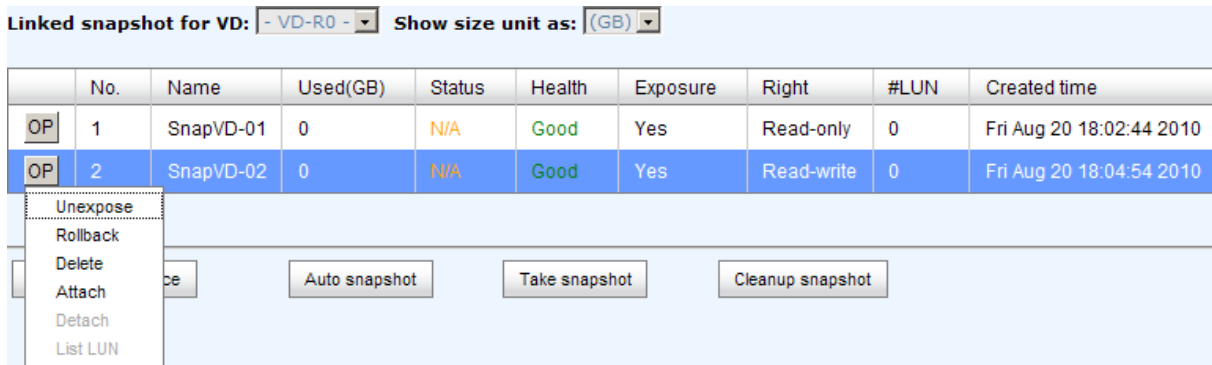

Figure 4.4.4.5

(Figure 4.4.4.5: This is the snapshot list of "VD-01". There are two snapshots. Snapshot VD "SnapVD-01" is exposed as read-only, "SnapVD-02" is exposed as read-write.)

Step 5: Attach a LUN to a snapshot VD. Please refer to the next section for attaching a LUN.

Step 6: Done. Snapshot VD can be used.

- **Snapshot column description:**

	The button includes the functions which can be executed.
Name	Snapshot VD name.
Used (GB) (MB)	The amount of snapshot space that has been used. The unit can be displayed in GB or MB.
Status	The status of snapshot: <ul style="list-style-type: none"> • "N/A" → The snapshot is normal. • "Replicated" → The snapshot is for clone or Replication usage. • "Abort" → The snapshot is over space and abort.
Health	The health of snapshot:

	<ul style="list-style-type: none"> • "Good" → The snapshot is good. • "Failed" → The snapshot fails.
Exposure	Snapshot VD is exposed or not.
Right	The right of snapshot: <ul style="list-style-type: none"> • "Read-write" → The snapshot VD can be read / write. • "Read-only" → The snapshot VD is read only.
#LUN	Number of LUN(s) that snapshot VD is attached.
Created time	Snapshot VD created time.

- **Snapshot operation description:**

Expose/ Unexpose	Expose / unexpose the snapshot VD.
Rollback	Rollback the snapshot VD.
Delete	Delete the snapshot VD.
Attach	Attach a LUN.
Detach	Detach a LUN.
List LUN	List attached LUN(s).

4.4.5 Logical unit

"Logical unit" can view, create, and modify the status of attached logical unit number(s) of each VD.

User can attach LUN by clicking the **"Attach"**. **"Host"** must enter with an iSCSI node name for access control, or fill-in wildcard **"*"**, which means every host can access the volume. Choose LUN number and permission, and then click **"OK"**.

Figure 4.4.5.1

Physical disk	RAID group	Virtual disk	Snapshot	Logical unit	Replication		
		Host	Target	LUN	Permission	VD name	#Session
OP		*	0	0	Read-write	r0	2
OP		*	1	1	Read-only	r1	2

Attach

Figure 4.4.5.2

- LUN operation description:**

Attach	Attach a logical unit number to a virtual disk.
Detach	Detach a logical unit number from a virtual disk.

The matching rules of access control are followed from the LUN' created time; the earlier created LUN is prior to the matching rules. For example: there are 2 LUN rules for the same VD, one is "*", LUN 0; and the other is "iqn.host1", LUN 1. The host "iqn.host2" can login successfully because it matches the rule 1.

Wildcard "*" and "?" are allowed in this field. "*" can replace any word. "?" can replace only one character. For example:

"iqn.host?" → "iqn.host1" and "iqn.host2" are accepted.

"iqn.host*" → "iqn.host1" and "iqn.host12345" are accepted.

This field can not accept comma, so "iqn.host1, iqn.host2" stands a long string, not 2 iqns.

4.4.6 Example

The following is an example to create volumes. This example is to create two VDs and set a global spare disk.

- **Example**

This example is to create two VDs in one RG, each VD shares the cache volume. The cache volume is created after system boots up automatically. Then set a global spare disk. Last, delete all of them.

Step 1: Create a RG (RAID group).

To create a RAID group, please follow the procedures:

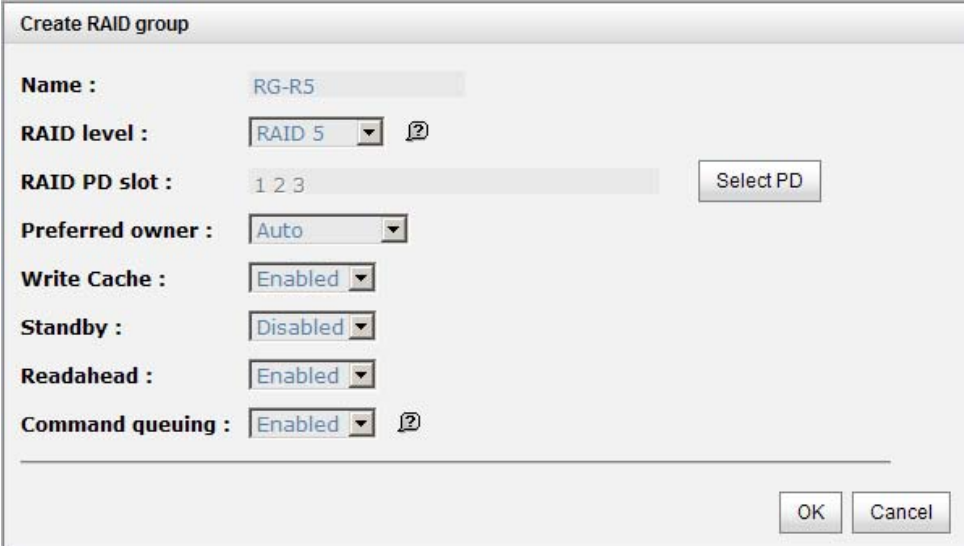

Figure 4.4.6.1

1. Select “/ Volume configuration / RAID group”.
2. Click “Create”.
3. Input a RG Name, choose a RAID level from the list, click “Select PD” to choose the RAID physical disks, then click “OK”.
4. Check the setting. Click “OK” if all setups are correct.
5. Done. A RG has been created.

Show size unit as: (GB) ▾

	Name	Total(GB)	Free(GB)	#PD	#VD	Status	Health	RAID	Current owner	Preferred owner
OP.	RG-R5	931	931	3	0	Online	Good	RAID 5	Controller 1	Controller 1

Figure 4.4.6.2

(Figure 4.4.6.2: Creating a RAID 5 with 3 physical disks, named “RG-R5”.)

Step 2: Create VD (Virtual Disk).

To create a data user volume, please follow the procedures.

The screenshot shows a 'Create' dialog box with the following configuration:

- Name: VD-R5-1
- RG name: RG-R5
- Capacity: 50 GB
- Stripe height (KB): 64
- Block size (B): 512
- Read/Write: Write-back cache (selected)
- Priority: High priority (selected)
- Bg rate: 4
- Readahead: Enabled
- AV-media mode: Disabled
- Erase: None
- Type: RAID

Figure 4.4.6.3

1. Select “/ Volume configuration / Virtual disk”.
2. Click “Create”.
3. Input a VD name, choose a RG Name and enter a size for this VD; decide the stripe height, block size, read / write mode, bg rate, and set priority, finally click “OK”.
4. Done. A VD has been created.
5. Follow the above steps to create another VD.

Show size unit as: (GB)

	Name	Size(GB)	Write	Priority	Bg rate	Type	Clone	Schedule	Status	Health	R %	RAID	#LUN	Snapshot space(GB)	#Snapshot	RG
OP	VD-R5-1	50	WB	HI	4	RAID	N/A	N/A	Initiating	Optimal	9	RAID 5	0	0/0	0	RG-R5
OP	VD-R5-2	64	WB	HI	4	RAID	N/A	N/A	Initiating	Optimal	0	RAID 5	0	0/0	0	RG-R5

Figure 4.4.6.4

(Figure 4.4.6.4: Creating VDs named “VD-R5-1” and “VD-R5-2” from RAID group “RG-R5”, the size of “VD-R5-1” is 50GB, and the size of “VD-R5-2” is 64GB. There is no LUN attached.)

Step 3: Attach a LUN to a VD.

There are 2 methods to attach a LUN to a VD.

1. In “/ Volume configuration / Virtual disk”, check the gray button next to the VD number; click “Attach LUN”.

2. In “/ Volume configuration / Logical unit”, click “Attach”.

The procedures are as follows:

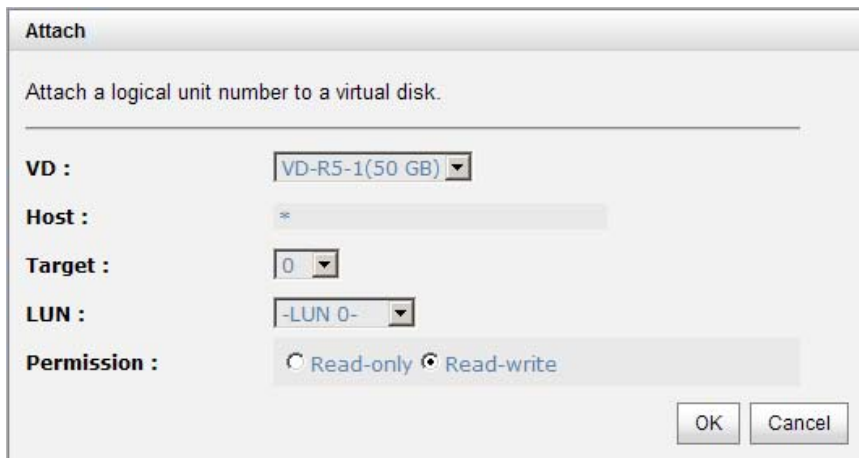

Figure 4.4.6.5

1. Select a VD.
2. Input “**Host**” IQN, which is an iSCSI node name for access control, or fill-in wildcard “*”, which means every host can access to this volume. Choose LUN and permission, and then click “**OK**”.
3. Done.

	Host	Target	LUN	Permission	VD name	#Session
	*	0	0	Read-write	VD-R5-1	0
	*	1	1	Read-write	VD-R5-2	0

Figure 4.4.6.6



Tips

The matching rules of access control are from the LUNs’ created time, the earlier created LUN is prior to the matching rules.

Step 4: Set a global spare disk.

To set a global spare disk, please follow the procedures.

1. Select “/ Volume configuration / Physical disk”.
2. Check the gray button next to the PD slot; click “**Set global space**”.
3. “**Global spare**” status is shown in “**Usage**” column.

Show PD for: [- Local -] Show size unit as: [(GB)]

	Slot	Size(GB)	RG	Status	Health	Usage	Vendor	Serial	Type	Write cache	Standby	Readahead	Command queuing
OP	1	465	RG-R5	Online	Good	RAID disk	SEAGATE	3QM00X1W00009843LV6Z	SAS	Enabled	Disabled	Enabled	Enabled
OP	2	465	RG-R5	Online	Good	RAID disk	SEAGATE	9QMBKDSX000099445E69	SAS	Enabled	Disabled	Enabled	Enabled
OP	3	465	RG-R5	Online	Good	RAID disk	SEAGATE	9QMBKV6R00009942TKPJ	SAS	Enabled	Disabled	Enabled	Enabled
OP	4	465		Online	Good	Global spare	SEAGATE	9QMBKE2W000099445C09	SAS	Enabled	Disabled	Enabled	Enabled
				Online	Good	Free disk	SEAGATE	9QMBKE81000099445DVM	SAS	Enabled	Disabled	Enabled	Enabled
				Online	Good	Free disk	SEAGATE	9QM4AFLD00009845WFC9	SAS	Enabled	Disabled	Enabled	Enabled
				Online	Good	Free disk	SEAGATE	9QMBWLL9000099003YYHD	SAS	Enabled	Disabled	Enabled	Enabled
				Online	Good	Free disk	SEAGATE	9QMBKQVP000099445B7N	SAS	Enabled	Disabled	Enabled	Enabled

- Set Free disk
- Set Global spare
- Set Dedicated spare
- Upgrade
- Disk Scrub
- Turn on the indication LED
- More information

Figure 4.4.6.7

(Figure 4.4.6.7: Slot 4 is set as a global spare disk.)

Step 5: Done.

Delete VDs, RG, please follow the below steps.

Step 6: Detach a LUN from the VD.

In **"/ Volume configuration / Logical unit"**,

	Host	Target	LUN	Permission	VD name	#Session
OP	*	0	0	Read-write	VD-R5-1	0
		1	1	Read-write	VD-R5-2	0

Figure 4.4.6.8

1. Check the gray button next to the LUN; click **"Detach"**. There will pop up a confirmation page.
2. Choose **"OK"**.
3. Done.

Step 7: Delete a VD (Virtual Disk).

To delete the virtual disk, please follow the procedures:

1. Select **"/ Volume configuration / Virtual disk"**.
2. Check the gray button next to the VD number; click **"Delete"**. There will pop up a confirmation page, click **"OK"**.
3. Done. Then, the VD is deleted.



Tips

When deleting VD directly, the attached LUN(s) of to this VD will be detached together.

Step 8: Delete a RG (RAID group).

To delete a RAID group, please follow the procedures:

1. Select **"/ Volume configuration / RAID group"**.
2. Select a RG which all its VD are deleted, otherwise the this RG cannot be deleted.
3. Check the gray button next to the RG number click **"Delete"**.
4. There will pop up a confirmation page, click **"OK"**.
5. Done. The RG has been deleted.



Tips

The action of deleting one RG will succeed only when all of the related VD(s) are deleted in this RG. Otherwise, user cannot delete this RG.

Step 9: Free a global spare disk.

To free a global spare disk, please follow the procedures.

1. Select **"/ Volume configuration / Physical disk"**.
2. Check the gray button next to the PD slot; click **"Set Free disk"**.

Step 10: Done, all volumes have been deleted.

4.5 Enclosure management

"Enclosure management" allows managing enclosure information including **"Hardware monitor"**, **"UPS"**, **"SES"**, and **"S.M.A.R.T."**. For the enclosure management, there are many sensors for different purposes, such as temperature sensors, voltage sensors, hard disk status, fan sensors, power sensors, and LED status. Due to the different hardware characteristics among these sensors, they have different polling intervals. Below are the details of the polling time intervals:

1. Temperature sensors: 1 minute.
2. Voltage sensors: 1 minute.
3. Hard disk sensors: 10 minutes.
4. Fan sensors: 10 seconds . When there are 3 errors consecutively, system sends ERROR event log.
5. Power sensors: 10 seconds, when there are 3 errors consecutively, system sends ERROR event log.
6. LED status: 10 seconds.

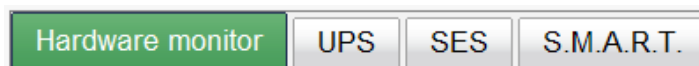

Figure 4.5.1

4.5.1 Hardware monitor

“Hardware monitor” can view the information of current voltages and temperatures.

Hardware monitor	UPS	SES	S.M.A.R.T.
Show information for: - Local - Temperature: (C)			
Controller 1			
Type	Item	Value	Status
Voltage	Onboard +1.2V	+1.18 V (min = +1.08 V, max = +1.32 V)	OK
Voltage	Onboard +3.3V	+3.28 V (min = +3.04 V, max = +3.56 V)	OK
Voltage	Onboard +5V	+5.02 V (min = +4.60 V, max = +5.40 V)	OK
Voltage	Onboard +12V	+11.93 V (min = +11.04 V, max = +12.96 V)	OK
Voltage	Onboard +1.8V	+1.79 V (min = +1.62 V, max = +1.98 V)	OK
Temperature	Core Processor	+44.0 (C) (hyst = +0.0 (C), high = +80.0 (C))	OK
Temperature	iSCSI NIC 1	+33.0 (C) (hyst = +0.0 (C), high = +65.0 (C))	OK
Temperature	iSCSI NIC 2	+32.5 (C) (hyst = +0.0 (C), high = +65.0 (C))	OK
Temperature	SAS Controller	+35.0 (C) (hyst = +0.0 (C), high = +65.0 (C))	OK
Temperature	SAS Expander	+30.0 (C) (hyst = +0.0 (C), high = +65.0 (C))	OK
Controller 2			
Type	Item	Value	Status
Voltage	Onboard +1.2V	+1.18 V (min = +1.08 V, max = +1.32 V)	OK
Voltage	Onboard +3.3V	+3.31 V (min = +3.04 V, max = +3.56 V)	OK
Voltage	Onboard +5V	+5.07 V (min = +4.60 V, max = +5.40 V)	OK
Voltage	Onboard +12V	+12.08 V (min = +11.04 V, max = +12.96 V)	OK
Voltage	Onboard +1.8V	+1.81 V (min = +1.62 V, max = +1.98 V)	OK
Temperature	Core Processor	+37.5 (C) (hyst = +0.0 (C), high = +80.0 (C))	OK
Temperature	iSCSI NIC 1	+33.5 (C) (hyst = +0.0 (C), high = +65.0 (C))	OK
Temperature	iSCSI NIC 2	+33.0 (C) (hyst = +0.0 (C), high = +65.0 (C))	OK
Temperature	SAS Controller	+33.0 (C) (hyst = +0.0 (C), high = +65.0 (C))	OK
Temperature	SAS Expander	+28.0 (C) (hyst = +0.0 (C), high = +65.0 (C))	OK
BPL			
Type	Item	Value	Status
Voltage	PSU +5V	+5.07 V (min = +4.60 V, max = +5.40 V)	OK
Voltage	PSU +12V	+12.08 V (min = +11.04 V, max = +12.96 V)	OK
Voltage	PSU +3.3V	+3.41 V (min = +3.04 V, max = +3.56 V)	OK
Temperature	Location 1	+23.0 (C) (hyst = +0.0 (C), high = +55.0 (C))	OK
Temperature	Location 2	+26.0 (C) (hyst = +0.0 (C), high = +55.0 (C))	OK
Temperature	Location 3	+24.0 (C) (hyst = +0.0 (C), high = +55.0 (C))	OK
Power Supply	PSU1	N/A	OK
Power Supply	PSU2	N/A	OK
Cooling	FAN1	10546 RPM	OK
Cooling	FAN2	10546 RPM	OK
Cooling	FAN3	10546 RPM	OK
Cooling	FAN4	11250 RPM	OK
Auto shutdown : <input checked="" type="checkbox"/>			
If 'Auto shutdown' has been checked, the system will shutdown automatically when voltage or temperature is out of the normal range.			
<input type="button" value="Confirm"/>			

Figure 4.5.1.1

If **“Auto shutdown”** is checked, the system will shutdown automatically when voltage or temperature is out of the normal range. For better data protection, please check **“Auto Shutdown”**.

For better protection and avoiding single short period of high temperature triggering auto shutdown, the system use multiple condition judgments to trigger auto shutdown, below are the details of when the Auto shutdown will be triggered.

1. There are several sensors placed on systems for temperature checking. System will check each sensor for every 30 seconds. When one of these sensor is over high temperature threshold for continuous 3 minutes, auto shutdown will be triggered immediately.
2. The core processor temperature limit is 80°C. The iSCSI NIC temperature limit is 65°C. The SAS expander and SAS controller temperature limit is 65°C.
3. If the high temperature situation doesn't last for 3 minutes, system will not trigger auto shutdown.

4.5.2 UPS

“UPS” can set up UPS (**U**ninterruptible **P**ower **S**upply).

Hardware monitor **UPS** SES S.M.A.R.T.

The system supports and communicates with smart-UPS of APC.
Choose Smart-UPS for APC, None for other vendors or no UPS.

UPS type : None

Shutdown battery level (%) : 0

Shutdown delay (s) : 0

Shutdown UPS : ON

Status :

Battery level : 0%

Confirm

Figure 4.5.2.1

(Figure 4.5.2.1: Without UPS.)

Currently, the system only supports and communicates with smart-UPS of APC (American Power Conversion Corp.) UPS. Please review the details from the website: <http://www.apc.com/>.

First, connect the system and APC UPS via RS-232 for communication. Then set up the shutdown values (shutdown battery level %) when power is failed. UPS in other companies can work well, but they have no such communication feature with the system.

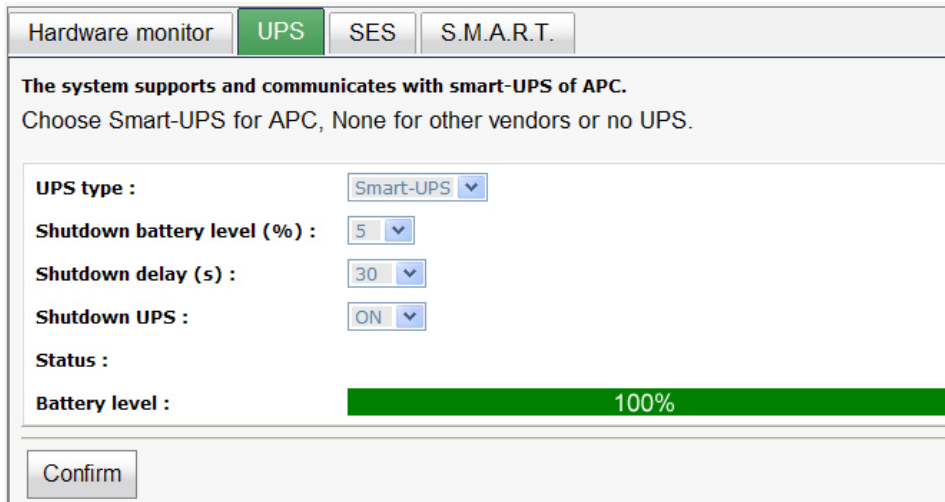

Figure 4.5.2.2

(Figure 4.5.2.2: With Smart-UPS.)

- **UPS column description:**

UPS Type	Select UPS Type. Choose Smart-UPS for APC, None for other vendors or no UPS.
Shutdown Battery Level (%)	When below the setting level, system will shutdown. Setting level to "0" will disable UPS.
Shutdown Delay (s)	If power failure occurs, and system power can not recover, the system will shutdown. Setting delay to "0" will disable the function.
Shutdown UPS	Select ON, when power is gone, UPS will shutdown by itself after the system shutdown successfully. After power comes back, UPS will start working and notify system to boot up. OFF will not.
Status	The status of UPS: <ul style="list-style-type: none"> • "Detecting..." • "Running" • "Unable to detect UPS" • "Communication lost" • "UPS reboot in progress"

	<ul style="list-style-type: none"> • "UPS shutdown in progress" • "Batteries failed. Please change them NOW!"
Battery Level (%)	Current power percentage of battery level.

4.5.3 SES

SES represents **SCSI Enclosure Services**, one of the enclosure management standards. **"SES configuration"** can enable or disable the management of SES.

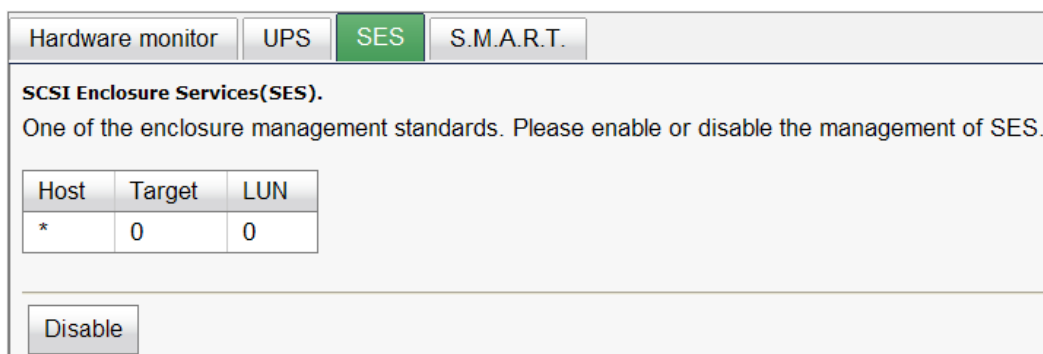

Figure 4.5.3.1

(Figure 4.5.1.1: Enable SES in LUN 0, and can be accessed from every host)

The SES client software is available at the following web site:

SANtools: <http://www.santools.com/>

4.5.4 Hard drive S.M.A.R.T.

S.M.A.R.T. (**S**elf-**M**onitoring **A**nalysis and **R**eporting **T**echnology) is a diagnostic tool for hard drives to deliver warning of drive failures in advance. S.M.A.R.T. provides users chances to take actions before possible drive failure.

S.M.A.R.T. measures many attributes of the hard drive all the time and inspects the properties of hard drives which are close to be out of tolerance. The advanced notice of possible hard drive failure can allow users to back up hard drive or replace the hard drive. This is much better than hard drive crash when it is writing data or rebuilding a failed hard drive.

"S.M.A.R.T." can display S.M.A.R.T. information of hard drives. The number is the current value; the number in parenthesis is the threshold value. The threshold values from different hard drive vendors are different; please refer to hard drive vendors' specification for details.

S.M.A.R.T. only supports SATA drives. SAS drives do not have this function now. It will show N/A in the web page for SAS drives.

Slot	HDD type	Read error (rate)	Spin up (time)	Reallocated sector (count)	Seek error (rate)	Spin up (retries)	Calibration (retries)	Temperature(C)
4	SAS	N/A	N/A	N/A	N/A	N/A	N/A	34
5	SAS	N/A	N/A	N/A	N/A	N/A	N/A	36
9	SAS	N/A	N/A	N/A	N/A	N/A	N/A	31
10	SATA2	94(6)	97(0)	97(36)	86(30)	100(97)	N/A	37
11	SATA2	109(6)	91(0)	49(36)	78(30)	100(97)	N/A	34
12	SATA2	185(51)	172(21)	200(140)	200(0)	100(0)	100(0)	36

Figure 4.5.4.1 (SAS drives & SATA drives)

4.6 System maintenance

“Maintenance” allows the operations of system functions which include “System information” to show the system version and details, “Event log” to view system event logs to record critical events, “Upgrade” to the latest firmware, “Firmware synchronization” to synchronized firmware versions on both controllers, “Reset to factory default” to reset all controller configuration values to factory settings, “Import and export” to import and export all controller configuration to a file, and “Reboot and shutdown” to reboot or shutdown the system.

System information	Event log	Upgrade	Firmware synchronization	Reset to factory default	Import and export	Reboot and shutdown
--------------------	-----------	---------	--------------------------	--------------------------	-------------------	---------------------

Figure 4.6.1

4.6.1 System information

“System information” can display system information, including CPU type, installed system memory, firmware version, serial numbers of dual controllers, backplane ID, and system status.

Item	Information
CPU type	XSC3-IOP8134x Family rev 9 (v5I)
System memory	ECC Unbuffered DDR-II 2048MB
Firmware version	DSN-6000 2.0.1
Serial number	001378BB0900 (Controller 1 : 500137800390AD98 , Controller 2 : 500137800390A5D8)
Backplane ID	DSN6000
JBOD serial no.	No JBOD connected
Status	Normal
Replication	Activated.

Figure 4.6.1.1

- **Status description:**

Normal	Dual controllers are in normal stage.
Degraded	One controller fails or has been plugged out.
Lockdown	The firmware of two controllers is different or the size of memory of two controllers is different.
Single	Single controller mode.

4.6.2 Event log

“**Event log**” can view the event messages. Check the checkbox of INFO, WARNING, and ERROR to choose the level of event log display. Click “**Download**” button to save the whole event log as a text file with file name “log-ModelName-SerialNumber-Date-Time.txt”. Click “**Clear**” button to clear all event logs. Click “**Mute**” button to stop alarm if system alerts.

System information **Event log** Upgrade Firmware synchronization Reset to

Select event level of displayed event log

INFO WARNING ERROR

<< first < prev **1** 2 3 4 5 6 7 8 9 10 next > last >>

Type	Time	Content
INFO	Tue, 11 Jan 2011 15:43:44	[CTR1] admin login from 192.168.8.174 via Web UI
INFO	Tue, 11 Jan 2011 14:58:54	[CTR1] admin login from 192.168.8.174 via Web UI
INFO	Tue, 11 Jan 2011 14:42:20	[CTR1] admin login from 192.168.8.174 via Web UI
INFO	Tue, 11 Jan 2011 14:11:43	[CTR1] Controller 1 restored to previous caching mode on failback.
INFO	Tue, 11 Jan 2011 14:11:19	[CTR2] Battery backup feature is disabled.
INFO	Tue, 11 Jan 2011 14:11:08	[CTR2] ECC memory is installed
INFO	Tue, 11 Jan 2011 14:11:11	[CTR1] admin login from 192.168.8.174 via Web UI
INFO	Tue, 11 Jan 2011 14:10:47	[CTR1] admin login from 192.168.156.10 via Web UI
INFO	Tue, 11 Jan 2011 14:10:33	[CTR1] All volumes in controller 1 completed failover process.
INFO	Tue, 11 Jan 2011 14:10:33	[CTR1] Controller 1 forced to adopt write-through mode on failover.
INFO	Tue, 11 Jan 2011 14:09:47	[CTR2] All volumes in controller 2 completed failback process.
INFO	Tue, 11 Jan 2011 14:09:47	[CTR2] Controller 2 restored to previous caching mode on failback.
INFO	Tue, 11 Jan 2011 14:09:25	[CTR1] Battery backup feature is disabled.
INFO	Tue, 11 Jan 2011 14:09:14	[CTR1] ECC memory is installed
INFO	Tue, 11 Jan 2011 14:08:34	[CTR2] All volumes in controller 2 completed failover process.

<< first < prev **1** 2 3 4 5 6 7 8 9 10 next > last >>

Download Mute Clear

Figure 4.6.2.1

The event log is displayed in reverse order which means the latest event log is on the first / top page. The event logs are actually saved in the first four hard drives; each hard drive has one copy of event log. For one system, there are four copies of event logs to make sure users can check event log any time when there are failed disks.



Tips

Please plug-in any of the first four hard drives, then event logs can be saved and displayed in next system boot up. Otherwise, the event logs cannot be saved and would be disappeared.

4.6.3 Upgrade

“Upgrade” can upgrade firmware. Please prepare new firmware file named “xxxx.bin” in local hard drive, then click “Browse” to select the file. Click “Confirm”, it will pop up a message “Upgrade system now? If you want to downgrade to the previous FW later (not recommend), please export your system configuration in advance”, click “Cancel” to export system configuration in advance, then click “OK” to start to upgrade firmware.



Figure 4.6.3.1

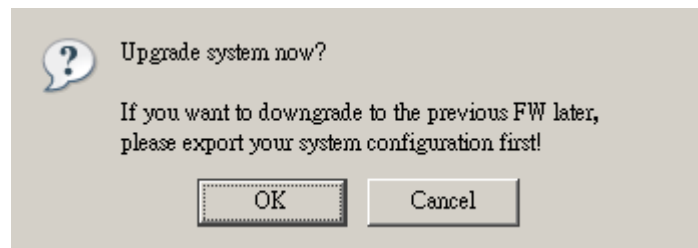

Figure 4.6.3.2

When upgrading, there is a progress bar running. After finished upgrading, the system must reboot manually to make the new firmware took effect.

4.6.4 Firmware synchronization

“Firmware synchronization” can synchronize the firmware version when controller 1 and controller 2’s firmware are different. It will upgrade the firmware of slave controller to master ones no matter what the firmware version of slave controller is newer or older than master. In normal status, the firmware versions in controller 1 and 2 are the same as below figure.

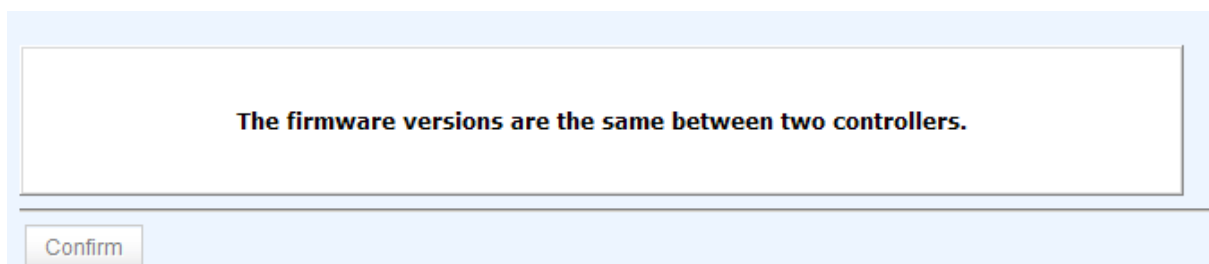
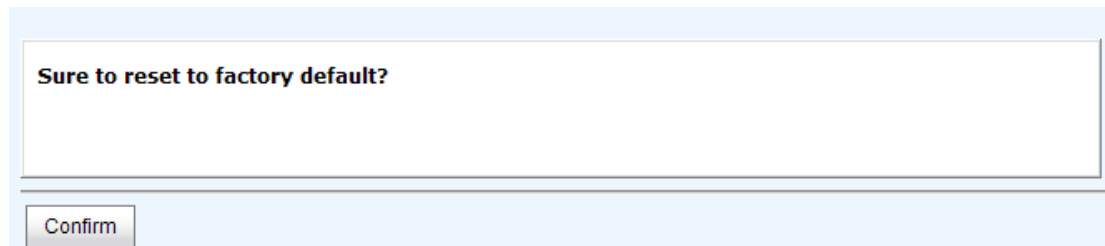

Figure 4.6.4.1

4.6.5 Reset to factory default

“Reset to factory default” allows user to reset IP SAN storage to factory default setting.



The screenshot shows a light blue dialog box with a white border. Inside, there is a text area containing the question "Sure to reset to factory default?". Below the text area is a single button labeled "Confirm".

Figure 4.6.5.1

Reset to default value, the password is: **1234**, and IP address to default 192.168.0.32

4.6.6 Import and export

“Import and export” allows user to save system configuration values: export, and apply all configuration: import. For the volume configuration setting, the values are available in export and not available in import which can avoid confliction / date-deleting between two IP SAN storages which mean if one system already has valuable volumes in the disks and user may forget and overwrite it. Use import could return to original configuration. If the volume setting was also imported, user’s current volumes will be overwritten with different configuration.

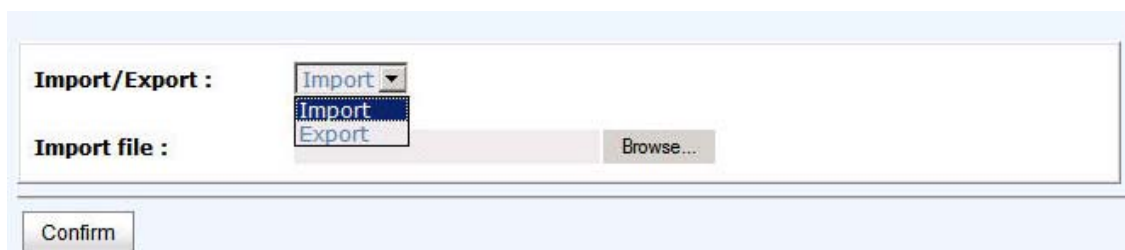

The screenshot shows a light blue dialog box with a white border. It contains two rows of controls. The first row is labeled "Import/Export :" and has a dropdown menu with "Import" selected. The second row is labeled "Import file :" and has a text input field followed by a "Browse..." button. Below these controls is a "Confirm" button.

Figure 4.6.6.1

1. **Import:** Import all system configurations excluding volume configuration.
2. **Export:** Export all configurations to a file.



Caution

“Import” will import all system configurations excluding volume configuration; the current configurations will be replaced.

4.6.7 Reboot and shutdown

“**Reboot and shutdown**” can “**Reboot**” and “**Shutdown**” the system. Before power off, it’s better to execute “**Shutdown**” to flush the data from cache to physical disks. The step is necessary for data protection.

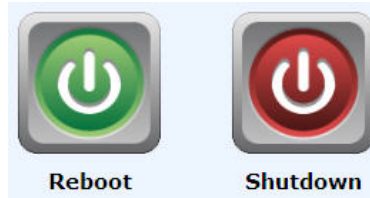

Figure 4.6.7.1

4.7 Home/Logout/Mute

In the right-upper corner of web UI, there are 3 individual icons, “**Home**”, “**Logout**”, and “**Mute**”.



Figure 4.7.1

4.7.1 Home

Click “**Home**” to return to home page.

4.7.2 Logout

For security reason, please use “**Logout**” to exit the web UI. To re-login the system, please enter username and password again.

4.7.3 Mute

Click “**Mute**” to stop the alarm when error occurs.

Chapter 5 Advanced operations

5.1 Volume rebuild

If one physical disk of the RG which is set as protected RAID level (e.g.: RAID 3, RAID 5, or RAID 6) is FAILED or has been unplugged / removed, then the status of RG is changed to degraded mode, the system will search/detect spare disk to rebuild the degraded RG to a complete one. It will detect dedicated spare disk as rebuild disk first, then global spare disk.

D-LINK IP SAN storage supports Auto-Rebuild. Take RAID 6 for example:

1. When there is no global spare disk or dedicated spare disk in the system, The RG will be in degraded mode and wait until (1) there is one disk assigned as spare disk, or (2) the failed disk is removed and replaced with new clean disk, then the Auto-Rebuild starts. The new disk will be a spare disk to the original RG automatically. If the new added disk is not clean (with other RG information), it would be marked as RS (reserved) and the system will not start "auto-rebuild". If this disk is not belonging to any existing RG, it would be FR (Free) disk and the system will start Auto-Rebuild. If user only removes the failed disk and plugs the same failed disk in the same slot again, the auto-rebuild will start running. But rebuilding in the same failed disk may impact customer data if the status of disk is unstable. **D-LINK** suggests all customers not to rebuild in the failed disk for better data protection.
2. When there is enough global spare disk(s) or dedicated spare disk(s) for the degraded array, system starts Auto-Rebuild immediately. And in RAID 6, if there is another disk failure occurs during rebuilding, system will start the above Auto-Rebuild process as well. Auto-Rebuild feature only works at that the status of RG is "**Online**". It will not work at "**Offline**". Thus, it will not conflict with the "**Online roaming**" feature.
3. In degraded mode, the status of RG is "**Degraded**". When rebuilding, the status of RG / VD will be "**Rebuild**", the column "**R%**" in VD will display the ratio in percentage. After complete rebuilding, the status will become "Online". RG will become completely one.



Tips

"**Set dedicated spare**" is not available if there is no RG or only RG of RAID 0, JBOD, because user can not set dedicated spare disk to RAID 0 and JBOD.

Sometimes, rebuild is called recover; they are the same meaning. The following table is the relationship between RAID levels and rebuild.

- **Rebuild operation description:**

RAID 0	Disk striping. No protection for data. RG fails if any hard drive fails or unplugs.
RAID 1	Disk mirroring over 2 disks. RAID 1 allows one hard drive fails or unplugging. Need one new hard drive to insert to the system and rebuild to be completed.
N-way mirror	Extension to RAID 1 level. It has N copies of the disk. N-way mirror allows N-1 hard drives failure or unplugging.
RAID 3	Striping with parity on the dedicated disk. RAID 3 allows one hard drive failure or unplugging.
RAID 5	Striping with interspersed parity over the member disks. RAID 5 allows one hard drive failure or unplugging.
RAID 6	2-dimensional parity protection over the member disks. RAID 6 allows two hard drives failure or unplugging. If it needs to rebuild two hard drives at the same time, it will rebuild the first one, then the other in sequence.
RAID 0+1	Mirroring of RAID 0 volumes. RAID 0+1 allows two hard drive failures or unplugging, but at the same array.
RAID 10	Striping over the member of RAID 1 volumes. RAID 10 allows two hard drive failure or unplugging, but in different arrays.
RAID 30	Striping over the member of RAID 3 volumes. RAID 30 allows two hard drive failure or unplugging, but in different arrays.
RAID 50	Striping over the member of RAID 5 volumes. RAID 50 allows two hard drive failures or unplugging, but in different arrays.
RAID 60	Striping over the member of RAID 6 volumes. RAID 60 allows four hard drive failures or unplugging, every two in different arrays.
JBOD	The abbreviation of " J ust a B unch O f D isks". No data protection. RG fails if any hard drive failures or unplugs.

5.2 RG migration

To migrate the RAID level, please follow below procedures.

1. Select “/ Volume configuration / RAID group”.
2. Check the gray button next to the RG number; click “Migrate”.
3. Change the RAID level by clicking the down arrow to “RAID 5”. There will be a pop-up which indicates that HDD is not enough to support the new setting of RAID level, click “Select PD” to increase hard drives, then click “OK” to go back to setup page. When doing migration to lower RAID level, such as the original RAID level is RAID 6 and user wants to migrate to RAID 0, system will evaluate whether this operation is safe or not, and appear a warning message of “Sure to migrate to a lower protection array?”.



Figure 5.2.1

4. Double check the setting of RAID level and RAID PD slot. If there is no problem, click “OK”.
5. Finally a confirmation page shows the detail of RAID information. If there is no problem, click “OK” to start migration. System also pops up a message of “Warning: power lost during migration may cause damage of data!” to give user warning. When the power is abnormally off during the migration, the data is in high risk.
6. Migration starts and it can be seen from the “status” of a RG with “Migrating”. In “/ Volume configuration / Virtual disk”, it displays a “Migrating” in “Status” and complete percentage of migration in “R%”.

Show size unit as: (GB) ▾

	Name	Total(GB)	Free(GB)	#PD	#VD	Status	Health	RAID	Current owner	Preferred owner
OP	RG-R0->R5	1396	1386	4	1	Migrating	Good	RAID 5	Controller 1	Controller 1

Figure 5.2.2

(Figure 5.2.2: A RAID 0 with 3 physical disks migrates to RAID 5 with 4 physical disks.)

Show size unit as: (GB) ▾

	Name	Size(GB)	Write	Priority	Bg rate	Type	Clone	Schedule	Status	Health	R %	RAID	#LUN	Snapshot space(GB)	#Snapshot	RG
OP	VD-R0->R5	10	WB	HI	4	RAID	N/A	N/A	Migrating	Optimal	3	RAID 5	0	0/0	0	RG-R0->R5

Figure 5.2.3

To do migration, the total size of RG must be larger or equal to the original RG. It does not allow expanding the same RAID level with the same hard disks of original RG. The below operations are not allowed when a RG is being migrated. System would reject these operations:

1. Add dedicated spare.
2. Remove a dedicated spare.
3. Create a new VD.
4. Delete a VD.
5. Extend a VD.
6. Scrub a VD.
7. Perform another migration operation.
8. Scrub entire RG.
9. Take a snapshot.
10. Delete a snapshot.
11. Expose a snapshot.
12. Rollback to a snapshot.



Caution

RG Migration cannot be executed during rebuilding or VD extension.

5.3 VD extension

To extend VD size, please follow the procedures.

1. Select “/ **Volume configuration / Virtual disk**”.
2. Check the gray button next to the VD number; click “**Extend**”.
3. Change the size. The size must be larger than the original, and then click “**OK**” to start extension.

Extend

To extend VD size, the input size must be larger than the original size.

Size : 20 GB

Free : 1386 GB

OK Cancel

Figure 5.3.1

4. Extension starts. If VD needs initialization, it will display an “**Initiating**” in “**Status**” and complete percentage of initialization in “**R%**”.

Show size unit as: (GB)

	Name	Size(GB)	Write	Priority	Bg rate	Type	Clone	Schedule	Status	Health	R %	RAID	#LUN	Snapshot space(GB)	#Snapshot	RG
OP	VD-R0->R5	20	WB	HI	4	RAID	N/A	N/A	Initiating	Optimal	46	RAID 5	0	0/0	0	RG-R0->R5

Figure 5.3.2



Tips

The size of VD extension must be larger than original.



Caution

VD Extension cannot be executed during rebuilding or migration.

5.4 Snapshot

Snapshot-on-the-box captures the instant state of data in the target volume in a logical sense. The underlying logic is Copy-on-Write -- moving out the data which would be written to certain location where a write action occurs since the time of data capture. The certain location, named as "Snap VD", is essentially a new VD which can be attached to a LUN provisioned to a host as a disk like other ordinary VDs in the system. Rollback restores the data back to the state of any time which was previously captured in case for any unfortunate reason it might be (e.g. virus attack, data corruption, human errors and so on). Snap VD is allocated within the same RG in which the snapshot is taken, we suggest to reserve 20% of RG size or more for snapshot space. Please refer to the following figure for snapshot concept.

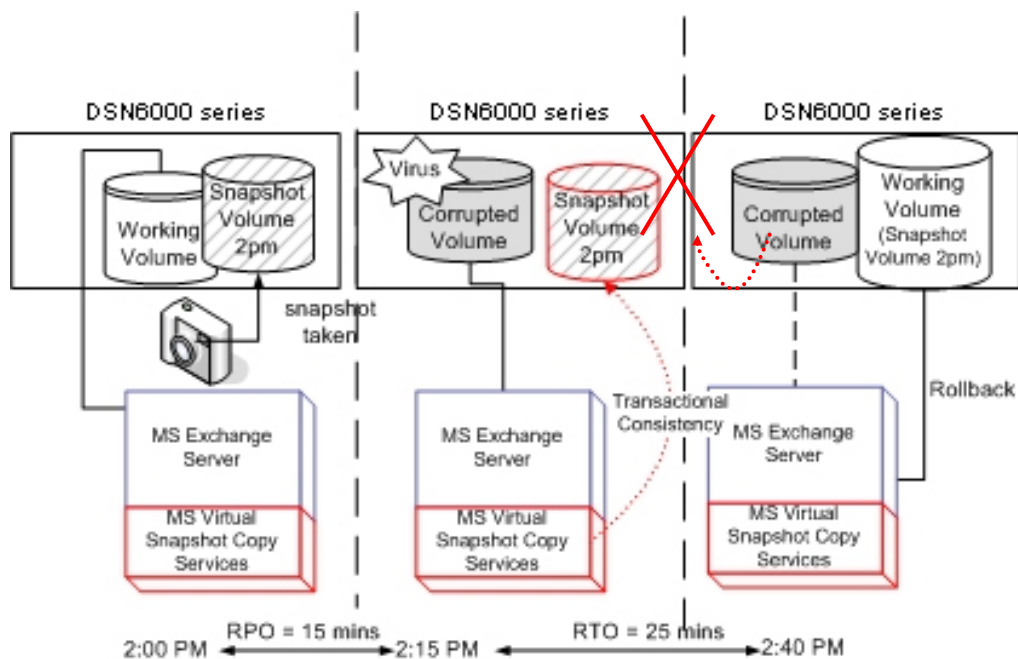

Figure 5.4.1

5.4.1 Create snapshot volume

To take a snapshot of the data, please follow the procedures.

1. Select “/ **Volume configuration / Virtual disk**”.
2. Check the gray button next to the VD number; click “**Set snapshot space**”.
3. Set up the size for snapshot. The minimum size is suggested to be **20%** of VD size, and then click “**OK**”. It will go back to the VD page and the size will show in snapshot column. It may not be the same as the number entered because some size is reserved for snapshot internal usage. There will be 2 numbers in “**Snapshot**” column. These numbers mean “**Used snapshot space**” and “**Total snapshot space**”.
4. There are two methods to take snapshot. In “/ **Volume configuration / Virtual disk**”, check the gray button next to the VD number; click “**Take snapshot**”. Or in “/ **Volume configuration / Snapshot**”, click “**Take snapshot**”.
5. Enter a snapshot name, and then click “**OK**”. A snapshot VD is created.
6. Select “/ **Volume configuration / Snapshot**” to display all snapshot VDs taken from the VD.

Linked snapshot for VD: - VD-R0 - Show size unit as: (GB)

	No.	Name	Used(GB)	Status	Health	Exposure	Right	#LUN	Created time
<input type="checkbox"/>	1	SnapVD-01	0	N/A	Good	No	N/A	N/A	Fri Aug 20 18:02:44 2010

Expose
Rollback
Delete

Auto snapshot Take snapshot Cleanup snapshot

Figure 5.4.1.1

7. Check the gray button next to the Snapshot VD number; click “**Expose**”. Enter a capacity for snapshot VD. If size is zero, the exposed snapshot VD is read only. Otherwise, the exposed snapshot VD can be read / written, and the size is the maximum capacity to read / write.
8. Attach a LUN to the snapshot VD. Please refer to the previous chapter for attaching a LUN.
9. Done. It can be used as a disk.

Linked snapshot for VD: - VD-R0 - Show size unit as: (GB)

	No.	Name	Used(GB)	Status	Health	Exposure	Right	#LUN	Created time
<input type="checkbox"/>	1	SnapVD-01	0	N/A	Good	Yes	Read-only	0	Fri Aug 20 18:02:44 2010
<input type="checkbox"/>	2	SnapVD-02	0	N/A	Good	Yes	Read-write	0	Fri Aug 20 18:04:54 2010

Unexpose
Rollback
Delete
Attach
Detach
List LUN

Auto snapshot Take snapshot Cleanup snapshot

Figure 5.4.1.2

(Figure 5.4.1.2: This is the snapshot list of “VD-01”. There are two snapshots. Snapshot VD “SnapVD-01” is exposed as read-only, “SnapVD-02” is exposed as read-write.)

1. There are two methods to clean all snapshots. In “/ **Volume configuration / Virtual disk**”, check the gray button next to the VD number; click “**Cleanup snapshot**”. Or in “/ **Volume configuration / Snapshot**”, click “**Cleanup**”.
2. “**Cleanup snapshot**” will delete all snapshots of the VD and release snapshot space.

5.4.2 Auto snapshot

The snapshot copies can be taken manually or by schedule such as hourly or daily. Please follow the procedures.

1. There are two methods to set auto snapshot. In “/ **Volume configuration / Virtual disk**”, check the gray button next to the VD number; click “**Auto snapshot**”. Or in “/ **Volume configuration / Snapshot**”, click “**Auto snapshot**”.
2. The auto snapshot can be set monthly, weekly, daily, or hourly.
3. Done. It will take snapshots automatically.

Auto snapshot

- VD-R0->R5 -

Months to take snapshots : All
 01 02 03 04
 05 06 07 08
 09 10 11 12

Weeks to take snapshots : All
 1 2 3 4
 5

Days to take snapshots : All
 Sun Mon Tue Wed
 Thu Fri Sat

Hours to take snapshots : All
 00 01 02 03
 04 05 06 07
 08 09 10 11
 12 13 14 15
 16 17 18 19
 20 21 22 23

OK Cancel

Figure 5.4.2.1

(Figure 5.4.2.1: It will take snapshots every month, and keep the last 32 snapshot copies.)



Tips

Daily snapshot will be taken at every 00:00. Weekly snapshot will be taken every Sunday 00:00. Monthly snapshot will be taken every first day of month 00:00.

5.4.3 Rollback

The data in snapshot VD can rollback to original VD. Please follow the procedures.

1. Select “/ **Volume configuration / Snapshot**”.
2. Check the gray button next to the Snap VD number which user wants to rollback the data; click “**Rollback**”.
3. Done, the data in snapshot VD is rollback to original VD.



Caution

Before executing rollback, it is better to dismount file system for flushing data from cache to disks in OS first. System sends pop-up message when user executes rollback function.

5.4.4 Snapshot constraint

D-LINK snapshot function applies Copy-on-Write technique on UDV/VD and provides a quick and efficient backup methodology. When taking a snapshot, it does not copy any data at first time until a request of data modification comes in. The snapshot copies the original data to snapshot space and then overwrites the original data with new changes. With this technique, snapshot only copies the changed data instead of copying whole data. It will save a lot of disk space.

- **Create a data-consistent snapshot**

Before using snapshot, user has to know why sometimes the data corrupts after rollback of snapshot. Please refer to the following diagram.

When user modifies the data from host, the data will pass through file system and memory of the host (write caching). Then the host will flush the data from memory to physical disks, no matter the disk is local disk (IDE or SATA), DAS (SCSI or SAS), or SAN (fibre or iSCSI). From the viewpoint of storage device, it can not control the behavior of host side. This case maybe happens. If user takes a snapshot, some data is still in memory and not flush to disk. Then the snapshot may have an incomplete image of original data. The problem does not belong to the storage device. To avoid this data inconsistent issue between snapshot and original data, user has to make the operating system flush the data from memory of host (write caching) into disk before taking snapshot.

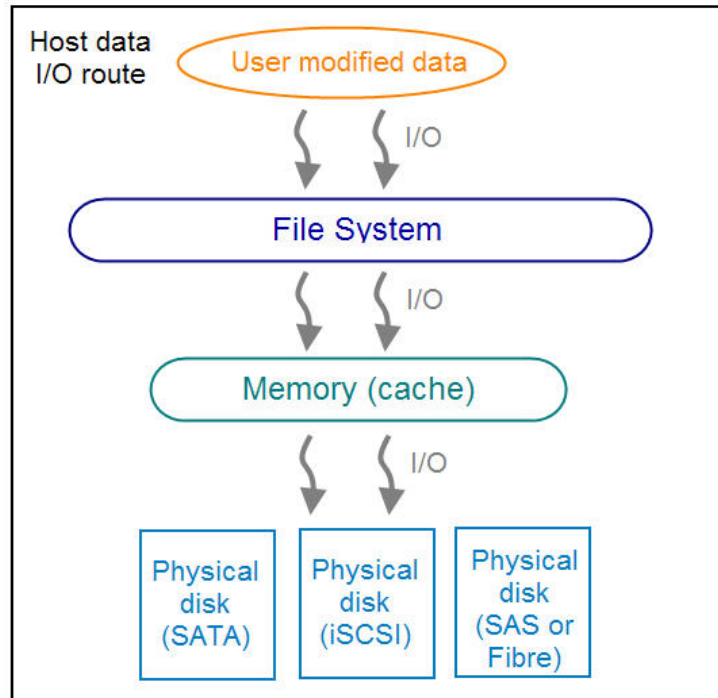

Figure 5.4.4.1

On Linux and UNIX platform, a command named **sync** can be used to make the operating system flush data from write caching into disk. For Windows platform, Microsoft also provides a tool – **sync**, which can do exactly the same thing as the **sync** command in Linux/UNIX. It will tell the OS to flush the data on demand. For more detail about **sync** tool, please refer to: <http://technet.microsoft.com/en-us/sysinternals/bb897438.aspx>

Besides the **sync** tool, Microsoft develops **VSS** (volume shadow copy service) to prevent this issue. VSS is a mechanism for creating consistent point-in-time copies of data known as shadow copies. It is a coordinator between backup software, application (SQL or Exchange..) and storages to make sure the snapshot without the problem of data-inconsistent. For more detail about the VSS, please refer to <http://technet.microsoft.com/en-us/library/cc785914.aspx>. **DSN-6110/6120** can support Microsoft VSS.

- **What if the snapshot space is over?**

Before using snapshot, a snapshot space is needed from RG capacity. After a period of working snapshot, what if the snapshot size over the snapshot space of user defined? There are two different situations:

1. If there are two or more snapshots existed, the system will try to remove the oldest snapshots (to release more space for the latest snapshot) until enough space is released.
2. If there is only one snapshot existed, the snapshot will fail. Because the snapshot space is run out.

For example, there are two or more snapshots existed on a VD and the latest snapshot keeps growing. When it comes to the moment that the snapshot space is run out, the system will try to remove the oldest snapshot to release more space for the latest snapshot usage. As the latest snapshot is growing, the system keeps removing the old snapshots. When it comes that the latest snapshot is the only one in system, there is no more snapshot space which can be released for incoming changes, then snapshot will fail.

- **How many snapshots can be created on a VD**

There are up to 32 snapshots can be created on a UDV/VD. What if the 33rd snapshot has been taken? There are two different situations:

1. If the snapshot is configured as **auto snapshot**, the latest one (the 33rd snapshot) will replace the oldest one (the first snapshot) and so on.
2. If the snapshot is taken manually, when taking the 33rd snapshot will fail and a warning message will be showed on Web UI.

- **Rollback / Delete snapshot**

When a snapshot has been rollbacked, the other snapshots which are earlier than it will also be removed. But the rest snapshots will be kept after rollback. If a snapshot has been deleted, the other snapshots which are earlier than it will also be deleted. The space occupied by these snapshots will be released after deleting.

5.5 Disk roaming

Physical disks can be re-sequenced in the same system or move all physical disks in the same RAID group from system-1 to system-2. This is called disk roaming. System can execute disk roaming online. Please follow the procedures.

1. Select **"/ Volume configuration / RAID group"**.
2. Check the gray button next to the RG number; click **"Deactivate"**.
3. Move all PDs of the RG to another system.
4. Check the gray button next to the RG number; click **"Activate"**.
5. Done.

Disk roaming has some constraints as described in the followings:

1. Check the firmware version of two systems first. It is better that either systems have the same firmware version or system-2 firmware version is newer.
2. All physical disks of the RG should be moved from system-1 to system-2 together. The configuration of both RG and VD will be kept but LUN configuration will be cleared in order to avoid conflict with system-2's original setting.

5.6 VD clone

The user can use VD clone function to backup data from source VD to target VD, set up backup schedule, and deploy the clone rules.

The procedures of VD clone are on the following:

1. Copy all data from source VD to target VD at the beginning (full copy).
2. Use Snapshot technology to perform the incremental copy afterwards. Please be fully aware that the incremental copy needs to use snapshot to compare the data difference. Therefore, the enough snapshot space for VD clone is very important.

The following contents will take an example of a RAID 5 virtual disk (SourceVD_Raid5) clone to RAID 6 virtual disk (TargetVD_Raid6).

- **Start VD clone**

1. Create a RAID group (RG) in advance.

Show size unit as: (GB) ▾

	Name	Total(GB)	Free(GB)	#PD	#VD	Status	Health	RAID	Current owner	Preferred owner
OP.	RG-R5	931	931	3	0	Online	Good	RAID 5	Controller 1	Controller 1
OP.	RG-R6	931	931	4	0	Online	Good	RAID 6	Controller 1	Controller 1

Figure 5.6.1

2. Create two virtual disks (VD) "SourceVD_R5" and "TargetVD_R6". The raid type of backup target needs to be set as "**BACKUP**".

The screenshot shows a 'Create' dialog box with the following configuration:

- Name: TargetVD_R6
- RG name: RG-R6
- Capacity: 20 GB
- Stripe height (KB): 64
- Block size (B): 512
- Read/Write: Write-back cache (selected)
- Priority: High priority (selected)
- Bg rate: 4
- Readahead: Enabled
- AV-media mode: Disabled
- Erase: None
- Type: BACKUP (selected)

Figure 5.6.2

- Here are the objects, a Source VD and a Target VD. Before starting clone process, it needs to deploy the VD Clone rule first. Click **“Configuration”**.

Show size unit as: (GB)

	Name	Size(GB)	Write	Priority	Bg rate	Type	Clone	Schedule	Status	Health	R %	RAID	#LUN	Snapshot space(GB)	#Snapshot	RG
OP	SourceVD_R5	20	WB	HI	4	RAID	N/A	N/A	Online	Optimal		RAID 5	0	0/0	0	RG-R5
OP	TargetVD_R6	20	WB	HI	4	BACKUP	N/A	N/A	Online	Optimal		RAID 6	0	0/0	0	RG-R6

Create Configuration

Figure 5.6.3

- There are three clone configurations, describe on the following.

Clone - Configuration

Snapshot space : 2

Threshold : 50%

Restart the task an hour later if failed :

OK Cancel

Figure 5.6.4

- Snapshot space:**

Clone - Configuration

Snapshot space : 2

Threshold :

Restart the task an hour later if failed

0.5
1
1.5
2
2.5
3

Figure 5.6.4

This setting is the ratio of source VD and snapshot space. The default ratio is 2 to 1. It means when the clone process is starting, the system will automatically use the free RG space to create a snapshot space which capacity is double the source VD.

- Threshold: (The setting will be effective after enabling schedule clone)**

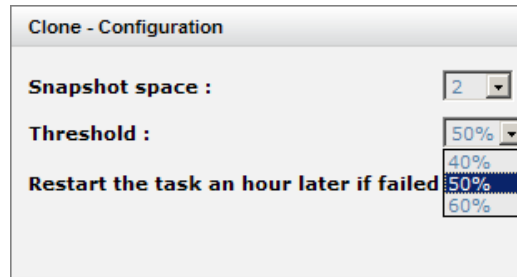

Figure 5.6.5

The threshold setting will monitor the usage amount of snapshot space. When the used snapshot space achieves its threshold, system will automatically take a clone snapshot and start VD clone process. The purpose of threshold could prevent the incremental copy fail immediately when running out of snapshot space.

For example, the default threshold is 50%. The system will check the snapshot space every hour. When the snapshot space is used over 50%, the system will synchronize the source VD and target VD automatically. Next time, when the rest snapshot space has been used 50%, in other words, the total snapshot space has been used 75%, the system will synchronize the source VD and target VD again.

- **Restart the task an hour later if failed: (The setting will be effective after enabling schedule clone)**

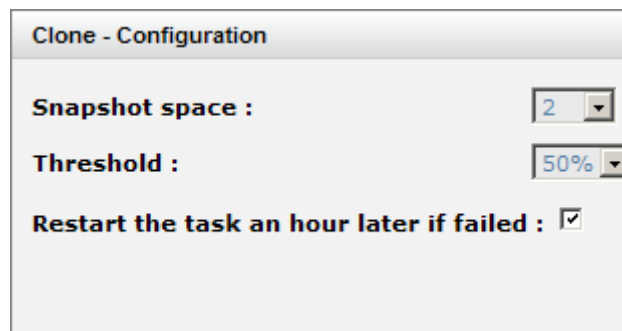

Figure 5.6.6

When running out of snapshot space, the VD clone process will be stopped because there is no more available snapshot space. If this option has been checked, system will clear the snapshots of clone in order to release snapshot space automatically, and the VD clone will restart the task after an hour. This task will start a full copy.

5. After deploying the VD clone rule, the VD clone process can be started now. Firstly, Click **"Set clone"** to set the target VD at the VD name "SourceVD_R5".

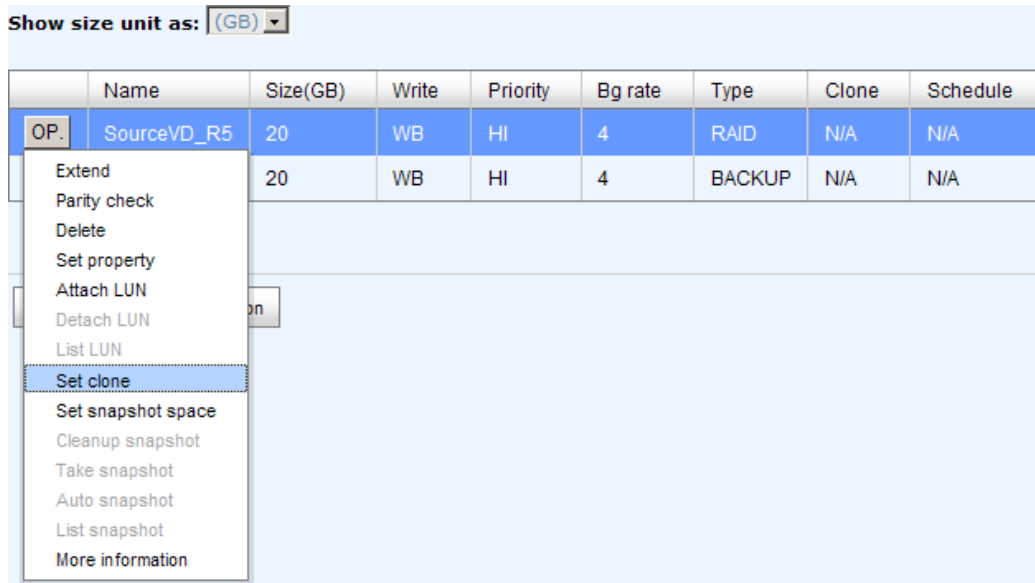

Figure 5.6.7

6. Select the target VD. Then click **“Confirm”**.

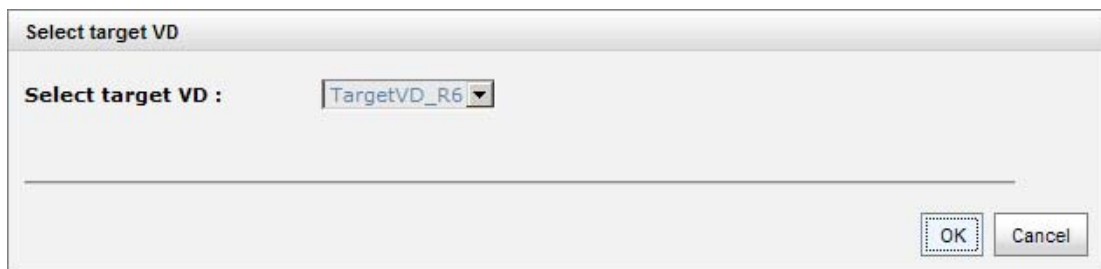

Figure 5.6.8

7. Now, the clone target "TargetVD_R6" has been set.

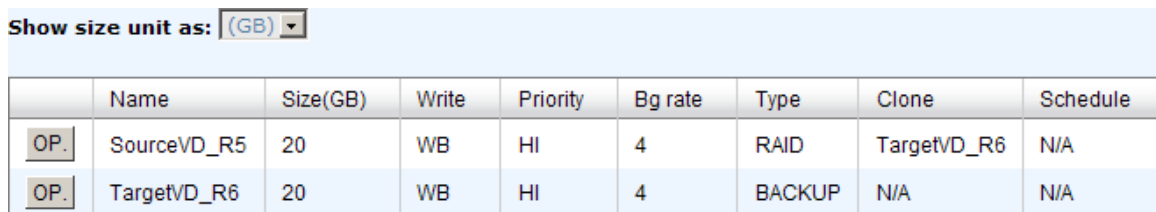

Figure 5.6.9

8. Click **“Start clone”**, the clone process will start.

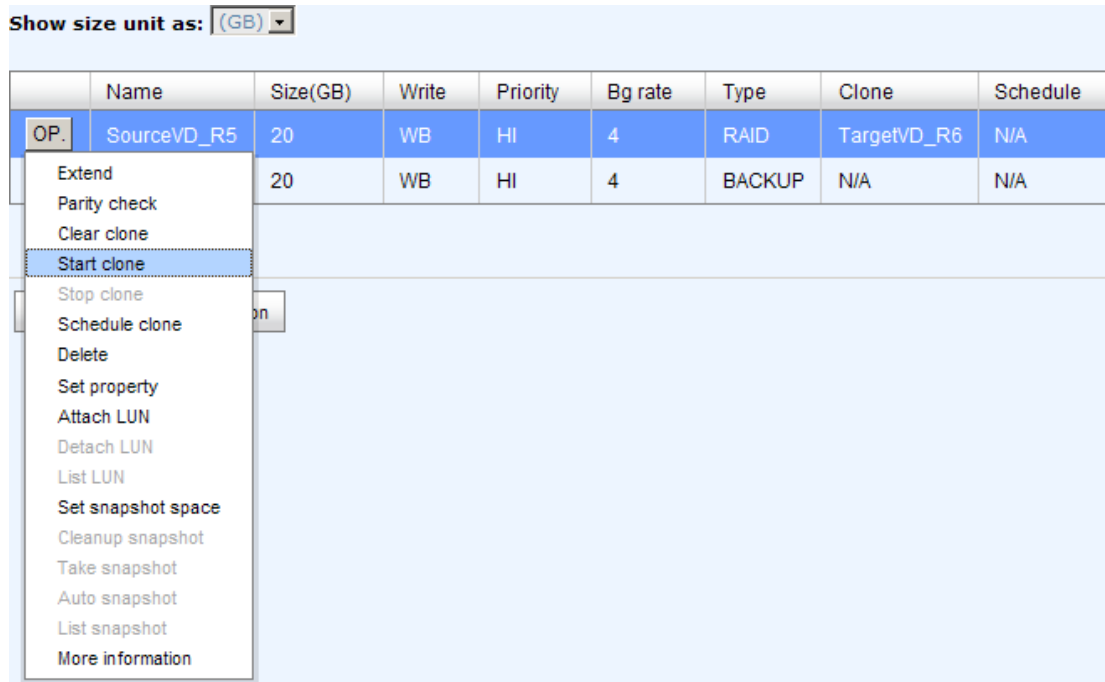

Figure 5.6.10

9. The default setting will create a snapshot space automatically which the capacity is double size of the VD space. Before starting clone, system will initiate the snapshot space.

Show size unit as: (GB) ▾

	Name	Size(GB)	Write	Priority	Bg rate	Type	Clone	Schedule	Status	Health	R %	RAID	#LUN	Snapshot space(GB)	#Snapshot	RG
OP.	SourceVD_R5	20	WB	HI	4	RAID	TargetVD_R6	N/A	Initiating	Optimal	33	RAID 5	0	1/41	1	RG-R5
OP.	TargetVD_R6	20	WB	HI	4	BACKUP	N/A	N/A	Online	Optimal		RAID 6	0	0/0	0	RG-R6

Figure 5.6.11

10. After initiating the snapshot space, it will start cloning.

Show size unit as: (GB) ▾

	Name	Size(GB)	Write	Priority	Bg rate	Type	Clone	Schedule	Status	Health	R %	RAID	#LUN	Snapshot space(GB)	#Snapshot	RG
OP.	SourceVD_R5	20	WB	HI	4	RAID	TargetVD_R6	N/A	Cloning	Optimal	37	RAID 5	0	1/41	1	RG-R5
OP.	TargetVD_R6	20	WB	HI	4	BACKUP	N/A	N/A	Online	Optimal		RAID 6	0	0/0	0	RG-R6

Figure 5.6.12

11. Click **“Schedule clone”** to set up the clone by schedule.

Show size unit as: (GB)

	Name	Size(GB)	Write	Priority	Bg rate	Type	Clone	Schedule
OP.	SourceVD_R5	20	WB	HI	4	RAID	TargetVD_R6	N/A
		20	WB	HI	4	BACKUP	N/A	N/A

Context menu for SourceVD_R5:

- Extend
- Parity check
- Clear clone
- Start clone
- Stop clone
- Schedule clone**
- Delete
- Set property
- Attach LUN
- Detach LUN
- List LUN
- Set snapshot space
- Cleanup snapshot
- Take snapshot
- Auto snapshot
- List snapshot
- More information

Figure 5.6.13

12. There are “**Set Clone schedule**” and “**Clear Clone schedule**” in this page. Please remember that “**Threshold**” and “**Restart the task an hour later if failed**” options in VD configuration will take effect after clone schedule has been set.

Clone - Set Clone schedule

Set Clone schedule

Scheduled time : 00:00

Back up everyday

Back up on a selected day in a week

Sunday Monday Tuesday Wednesday

Thursday Friday Saturday

Back up on the 1st day in a month

Clear Clone schedule

OK Cancel

Figure 5.6.14

- **Run out of snapshot space while VD clone**

While the clone is processing, the increment data of this VD is over the snapshot space. The clone will complete, but the clone snapshot will fail. Next time, when trying to start clone, it will get a warning message “This is not enough of snapshot space for the operation”. At this time, the user needs to clean up the snapshot space in order to operate

the clone process. Each time the clone snapshot failed, it means that the system loses the reference value of incremental data. So it will start a full copy at next clone process.

When running out of snapshot space, the flow diagram of VD clone procedure will be like the following.

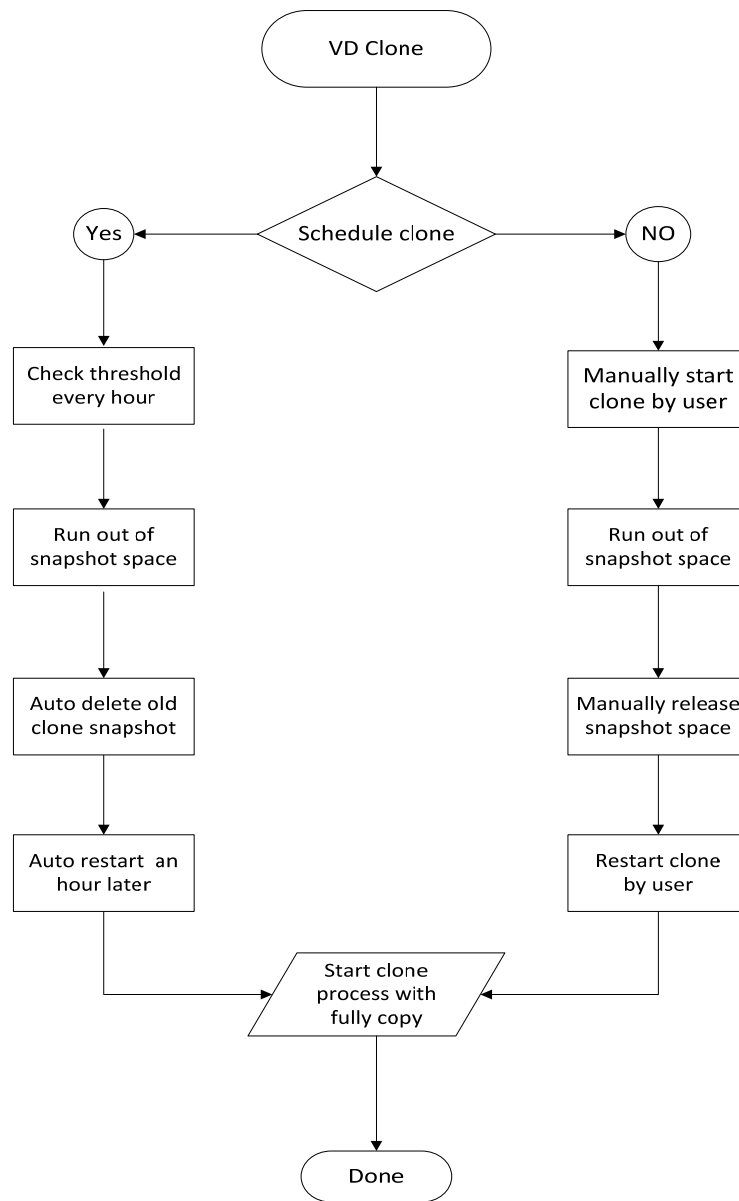

Figure 5.6.15

5.7 SAS JBOD expansion

5.7.1 Connecting JBOD

D-LINK DSN-6000 series support up to 4 additional SAS/SATA JBODs for capacity expansion. When connecting to a dual-controller JBOD, it will display in **“Show PD for:”** of **“/ Volume configuration / Physical disk”**. For example, Local, JBOD 1 (**DSN-6020**), JBOD 2 (**DSN-6020**), ...etc. Local means disks in local controller, and so on. The hard drives in JBOD can be used as local disks.

“/ Enclosure management / Hardware monitor” can display the hardware status of SAS JBODs.

“/ Enclosure management / S.M.A.R.T.” can display S.M.A.R.T. information of all PDs, including Local and all SAS JBODs.

SAS JBOD expansion has some constraints as described in the followings:

- 1 User could create RAID group among multiple chassis, max number of disks in a single RAID group is 32.
- 2 Global spare disk can support all RAID groups which located in the different chassis.
- 3 When support SATA drives for the redundant JBOD model, the SATA bridge board is required.
- 4 The following table is the maximum JBOD numbers and maximum HDD numbers with different chassis can be cascaded.

RAID Storage System	Dual controllers + Dual JBOD
	DSN-6120
DSN-6020 no.	4
Max HDD no.	60

5.7.2 Upgrade firmware of JBOD

To upgrade the firmware of JBOD, please follow the procedures.

- 1 There is a hidden web page for JBOD firmware upgrade. Please login Web UI as username admin first, and then add this URL to the browser. (http://Management IP/jbod_upg.php), for example:

http://192.168.10.50/jbod_upg.php

FOLLOW THE STEPS TO UPGRADE THE FIRMWARE OF JBOD

Step 1: Choose a JBOD :

Step 2: Browse the firmware to upgrade :

Step 3: Make sure Step 1 & 2 is correct, then Confirm!

Figure 5.7.2.1

- 2 Choose a JBOD which wants to upgrade.
- 3 Please prepare new firmware file in local hard drive, then click "**Browse**" to select the file. Click "**Confirm**".
- 4 After finished upgrading, the system must reboot manually to make the new firmware took effect.

5.8 MPIO and MC/S

These features come from iSCSI initiator. They can be setup from iSCSI initiator to establish redundant paths for sending I/O from the initiator to the target.

1. **MPIO:** In Microsoft Windows server base system, Microsoft MPIO driver allows initiators to login multiple sessions to the same target and aggregate the duplicate devices into a single device. Each session to the target can be established using different NICs, network infrastructure and target ports. If one session fails, then another session can continue processing I/O without interruption to the application.

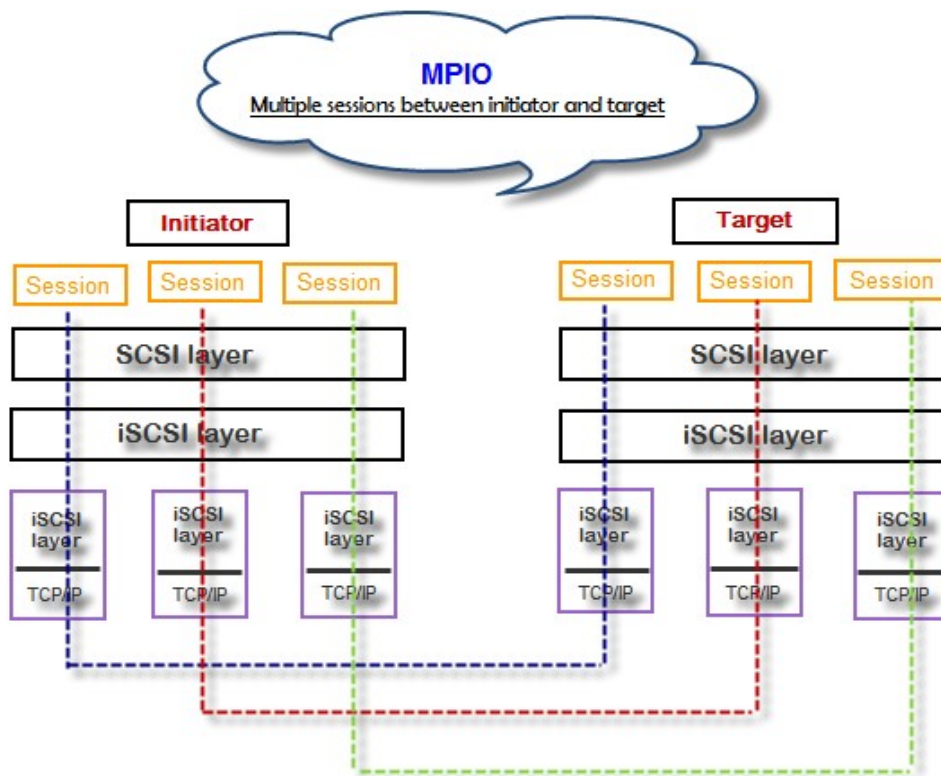

Figure 5.8.1

2. **MC/S:** MC/S (Multiple Connections per Session) is a feature of iSCSI protocol, which allows combining several connections inside a single session for performance and failover purposes. In this way, I/O can be sent on any TCP/IP connection to the target. If one connection fails, another connection can continue processing I/O without interruption to the application.

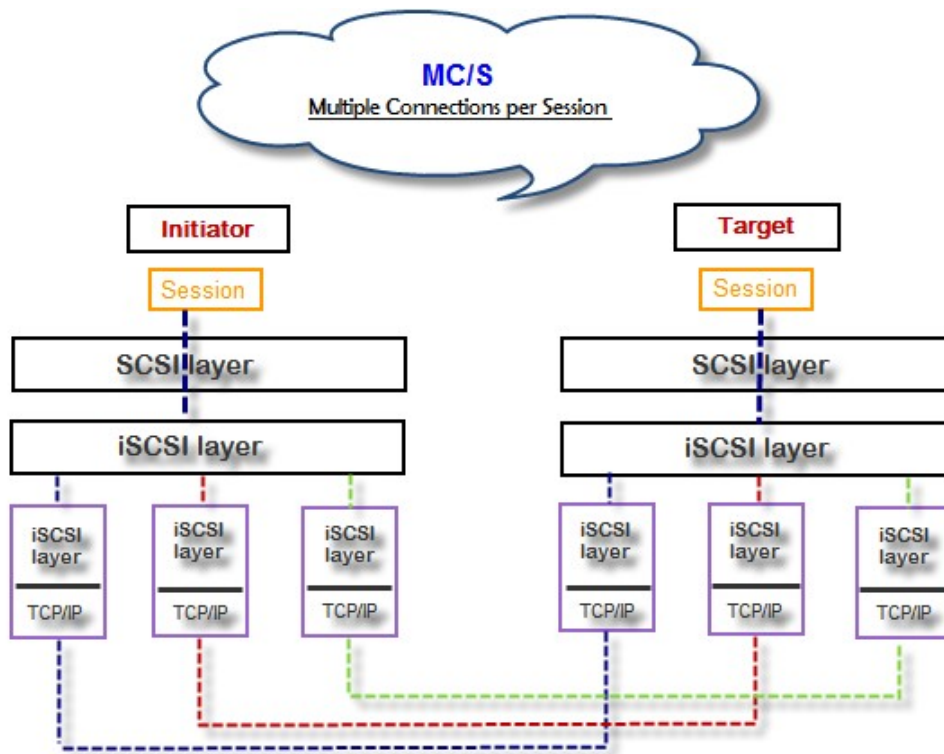

Figure 5.8.2

Difference:

MC/S is implemented on iSCSI level, while MPIO is implemented on the higher level. Hence, all MPIO infrastructures are shared among all SCSI transports, including Fiber Channel, SAS, etc. MPIO is the most common usage across all OS vendors. The primary difference between these two is which level the redundancy is maintained. MPIO creates multiple iSCSI sessions with the target storage. Load balance and failover occurs between the multiple sessions. MC/S creates multiple connections within a single iSCSI session to manage load balance and failover. Notice that iSCSI connections and sessions are different than TCP/IP connections and sessions. The above figures describe the difference between MPIO and MC/S.

There are some considerations when user chooses MC/S or MPIO for multipathing.

1. If user uses hardware iSCSI off-load HBA, then MPIO is the only one choice.
2. If user needs to specify different load balance policies for different LUNs, then MPIO should be used.

3. If user installs anyone of Windows XP, Windows Vista or Windows 7, MC/S is the only option since Microsoft MPIO is supported Windows Server editions only.
4. MC/S can provide higher throughput than MPIO in Windows system, but it consumes more CPU resources than MPIO.

5.9 Trunking and LACP

Link aggregation is the technique of taking several distinct Ethernet links to let them appear as a single link. It has a larger bandwidth and provides the fault tolerance ability. Beside the advantage of wide bandwidth, the I/O traffic remains operating until all physical links fail. If any link is restored, it will be added to the link group automatically. **D-LINK** implements link aggregation as LACP and Trunking.

1. **LACP (IEEE 802.3ad)**: The Link Aggregation Control Protocol (LACP) is a part of IEEE specification 802.3ad. It allows bundling several physical ports together to form a single logical channel. A network switch negotiates an automatic bundle by sending LACP packets to the peer. Theoretically, LACP port can be defined as active or passive. **D-LINK** IP SAN Storage implements it as active mode which means that LACP port sends LACP protocol packets automatically. Please notice that using the same configurations between **D-LINK** IP SAN Storage and gigabit switch.

The usage occasion of LACP:

- A. It's necessary to use LACP in a network environment of multiple switches. When adding new devices, LACP will separate the traffic to each path dynamically.

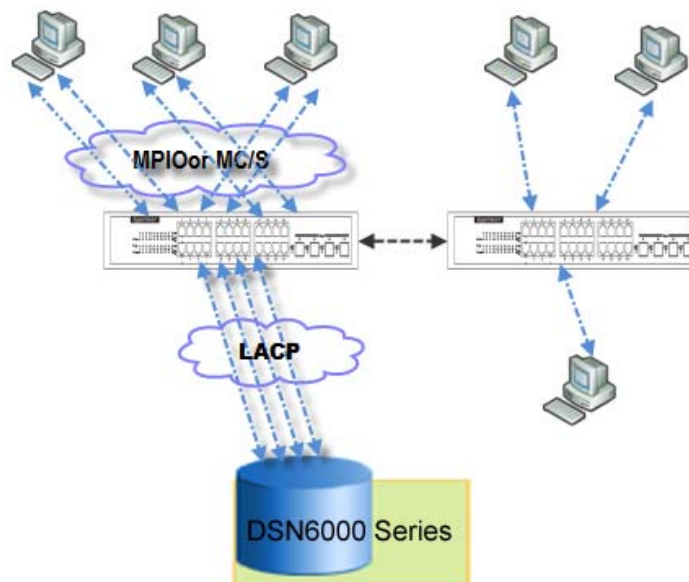

Figure 5.9.1

2. **Trunking (Non-protocol)**: Defines the usage of multiple iSCSI data ports in parallel to increase the link speed beyond the limits of any single port.

The usage occasion of Trunking:

- A. This is a simple SAN environment. There is only one switch to connect the server and storage. And there is no extra server to be added in the future.
- B. There is no idea of using LACP or Trunking, uses Trunking first.
- C. There is a request of monitoring the traffic on a trunk in switch.

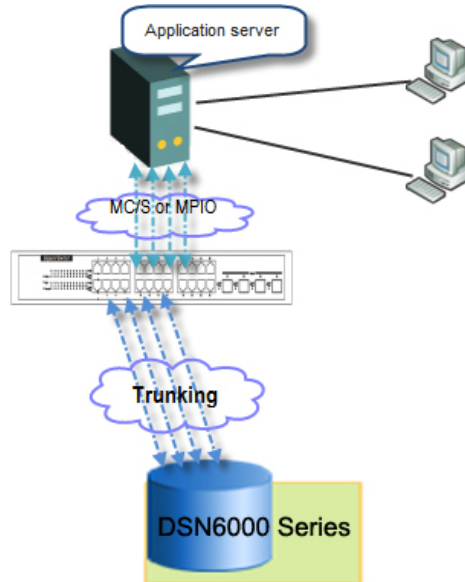

Figure 5.9.2



Caution

Before using trunking or LACP, the gigabit switch must support trunking or LACP and enabled. Otherwise, host can not connect the link with storage device.

5.10 Dual controllers (only for DSN-6120)

5.10.1 Perform I/O

Please refer to the following topology and have all the connections ready. To perform I/O on dual controllers, server/host should setup MPIO. MPIO policy will keep I/O running and prevent fail connection with single controller failure.

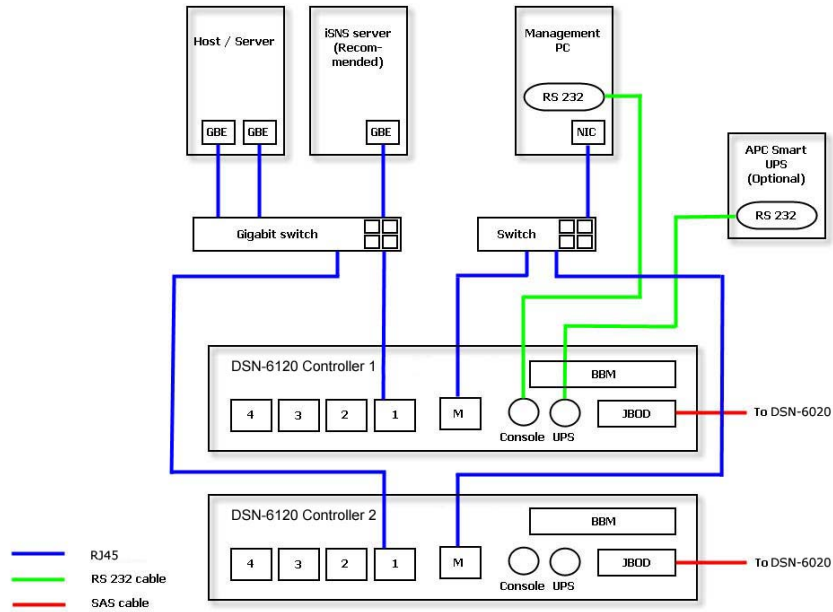

Figure 5.10.1.1

5.10.2 Ownership

When creating RG, it will be assigned with a preferred owner, the default owner is controller 1. To change the RG ownership, please follow the procedures.

- 1 Select **"/ Volume configuration / RAID group"**.
- 2 Check the gray button next to the RG name; click **"Set preferred owner"**.
- 3 The ownership of the RG will be switched to the other controller.

Physical disk **RAID group** Virtual disk Snapshot Logical unit Replication

Show size unit as: (GB) ▾

	Name	Total(GB)	Free(GB)	#PD	#VD	Status	Health	RAID	Current owner	Preferred owner
OP.	0	136	85	2	2	Online	Good	RAID 0	Controller 1	Controller 1

- Migrate
- Move
- Activate
- Deactivate
- Parity check
- Delete
- Set preferred owner**
- Set disk property
- More information

Figure 5.10.2.1

Physical disk	RAID group	Virtual disk	Snapshot	Logical unit	Replication					
Show size unit as: (GB) ▼										
	Name	Total(GB)	Free(GB)	#PD	#VD	Status	Health	RAID	Current owner	Preferred owner
OP.	0	136	85	2	2	Online	Good	RAID 0	Controller 2	Controller 2
Create										

Figure 5.10.2.2

(Figure 5.10.2.2: The RG ownership is changed to the other controller.)

5.10.3 Controller status

There are four statuses described on the following. It can be found in “/ **System maintenance / System information**”.

1. **Normal:** Dual controller mode. Both of controllers are functional.
2. **Degraded:** Dual controller mode. When one controller fails or has been plugged out, the system will turn to degraded. In this stage, I/O will force to write through for protecting data and the ownership of RG will switch to good one. For example: if controller 1 which owns the RG1 fails accidentally, the ownership of RG1 will be switched to controller 2 automatically. And the system and data can keep working well. After controller 1 is fixed or replaced, The current owner of all RGs will be assigned back to their preferred owner.
3. **Lockdown:** Dual controller mode. The firmware of two controllers is different or the size of memory of two controllers is different. In this stage, only master controller can work and I/O will force to write through for protecting data.
4. **Single:** Single controller mode. In the stage, the controller must stay in slot A. Multiplexer boards for SATA drives are not necessary. The differences between single and degraded are described on the following. There is no error message for inserted one controller only. I/O will not force to write through. And there is no ownership of RG. Single controller mode can be upgraded to dual controller mode, please contact the distributor for upgradable.

In addition, iSNS server is recommended. It's important for keeping I/O running smoothly when RG ownership is switching or single controller is failed. Without iSNS server, when controller 1 fails, the running I/O from host to controller 1 may fail because the time which host switches to the new portal is slower than I/O time out. With iSNS server, this case would not happen.

5.11 Replication

Replication function will help users to replicate data easily through LAN or WAN from one IP SAN storage to another.

The procedures of Replication are on the following:

1. Copy all data from source VD to target VD at the beginning (full copy).
2. Use Snapshot technology to perform the incremental copy afterwards. Please be fully aware that the incremental copy needs to use snapshot to compare the data difference. Therefore, the enough snapshot space for VD clone is very important.

- **Setup the Replication port on the source IP SAN storage**

The **Replication** uses the last iSCSI port on the controller to replicate the data. That is the forth iSCSI port on **DSN-6110/ 6120**. When the iSCSI is configured as **Replication** port, it is no longer available for the host to connected as iSCSI port until it is configured as the normal iSCSI port again.

1. In the operation menu of the last iSCSI port on the controller, select “**Enable Replication**” to set this port as the **Replication** port. The last iSCSI port on controller 2 will also be set as the **Replication** port automatically at the same time.

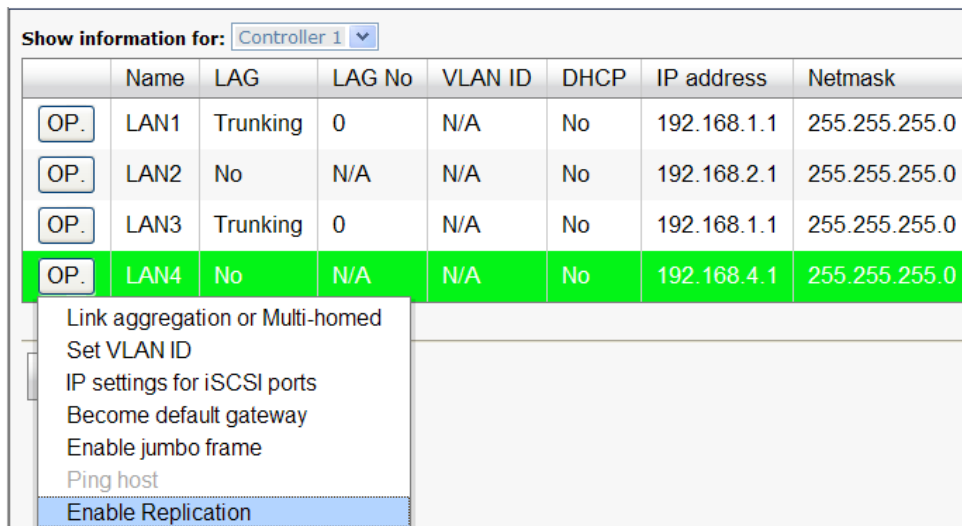

Show information for: Controller 1

	Name	LAG	LAG No	VLAN ID	DHCP	IP address	Netmask
<input type="button" value="OP."/>	LAN1	Trunking	0	N/A	No	192.168.1.1	255.255.255.0
<input type="button" value="OP."/>	LAN2	No	N/A	N/A	No	192.168.2.1	255.255.255.0
<input type="button" value="OP."/>	LAN3	Trunking	0	N/A	No	192.168.1.1	255.255.255.0
<input type="button" value="OP."/>	LAN4	No	N/A	N/A	No	192.168.4.1	255.255.255.0

- Link aggregation or Multi-homed
- Set VLAN ID
- IP settings for iSCSI ports
- Become default gateway
- Enable jumbo frame
- Ping host
- Enable Replication**

Figure 5.11.1

2. The setting can be reverted by selecting “**Disable Replication**” in the menu.

Show information for: Controller 1

	Name	LAG	LAG No	VLAN ID	DHCP	IP address	Netmask
<input type="button" value="OP."/>	LAN1	Trunking	0	N/A	No	192.168.1.1	255.255.255.0
<input type="button" value="OP."/>	LAN2	No	N/A	N/A	No	192.168.2.1	255.255.255.0
<input type="button" value="OP."/>	LAN3	Trunking	0	N/A	No	192.168.1.1	255.255.255.0
<input type="button" value="OP."/>	REP	N/A	N/A	N/A	No	192.168.4.1	255.255.255.0

Figure 5.11.2

3. If you want the replication port to be on special VLAN section, you may assign VLAN ID to the replication port. The setting will automatically duplicate to the other controller.

- **Create backup VD on the target IP SAN storage**

1. Before creating the replication job on the source IP SAN storage, user has to create a virtual disk on the target IP SAN storage and set the type of the VD as **“Backup”**.

Create

Name :

RG name :

Capacity :

Stripe height (KB) :

Block size (B) :

Read/Write : Write-through cache Write-back cache

Priority : High priority Middle priority Low priority

Bg rate :

Readahead :

AV-media mode :

Erase :

Type :

Figure 5.11.4

2. The backup VD needs to be attached to a LUN ID first before creating replication job.

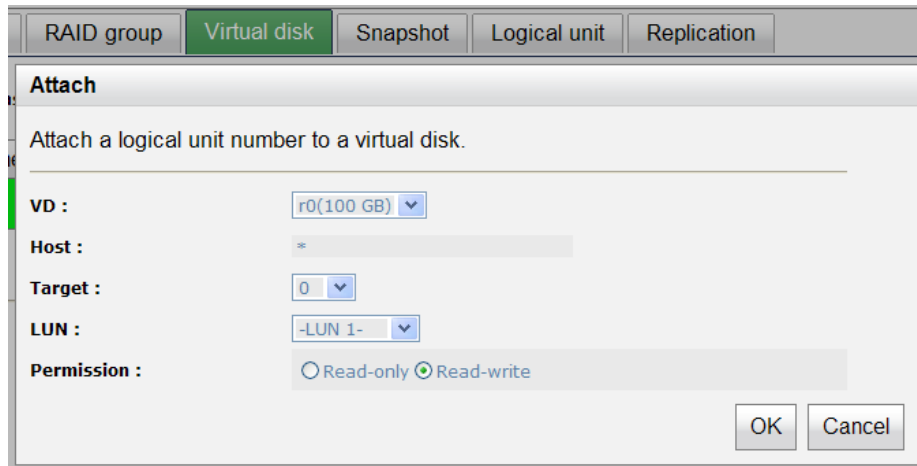

Figure 5.11.5

- **Create replication job on the source IP SAN storage**

1. Click **“Create”** to create a new replication job.

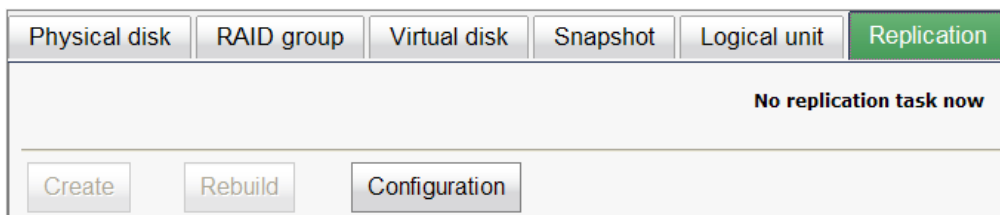

Figure 5.11.6

2. Select the source VD which will be replicated to the target IP SAN storage and click **“Next”**.



Figure 5.11.7



Tips

If the message displays that there is not enough space for creation, please refer to the section of **Configure the snapshot space** below for solution.

3. Enter the IP address of iSCSI port on controller 1 of the target IP SAN storage. Click **"Next"** to continue.

Replication - Select target IP

IP : 192.168.1.11

Cancel << Back Next >>

Figure 5.11.8

4. The Replication uses standard iSCSI protocol for data replication. User has to log on the iSCSI node to create the iSCSI connection for the data transmission. Enter the **CHAP** information if necessary and select the target node to log no. Click **"Next"** to continue.

Replication - Get login information

Choose authentication method.

No Authentication method

CHAP

User : (max: 223)

Secret : (min: 12, max: 16)

Select a target node

No.	Name
<input checked="" type="radio"/> 1	d-link:dsn-6000:dev0.ctr1

Cancel << Back Next >>

Figure 5.11.9

5. Choose the backup VD and click **“Next”**.

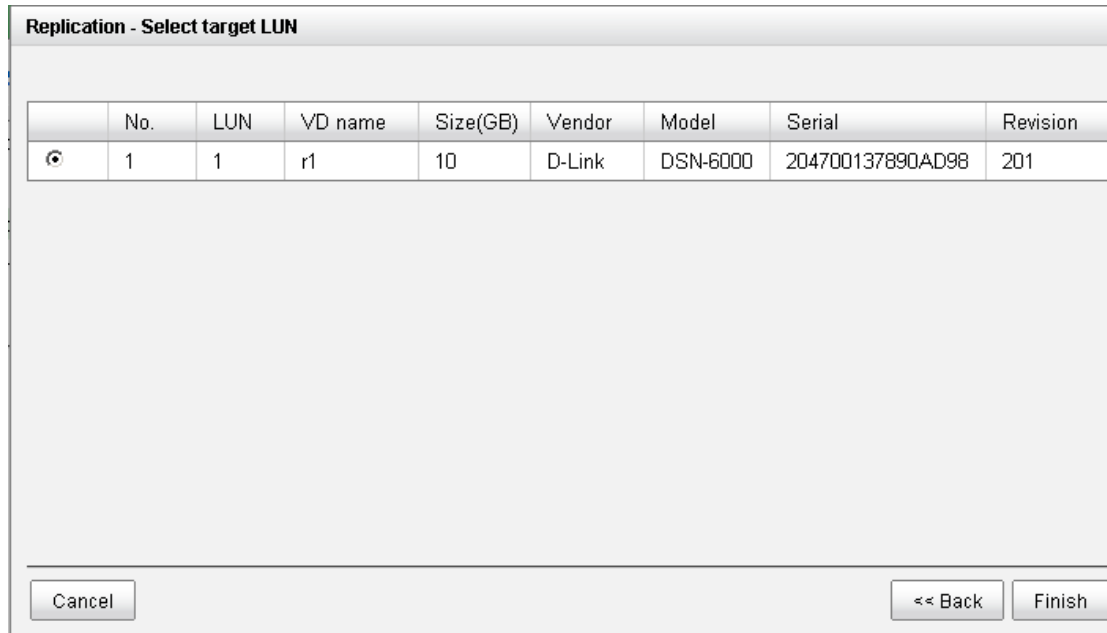

Figure 5.11.10

6. A new replication job is created and listed on the **Replication** page.

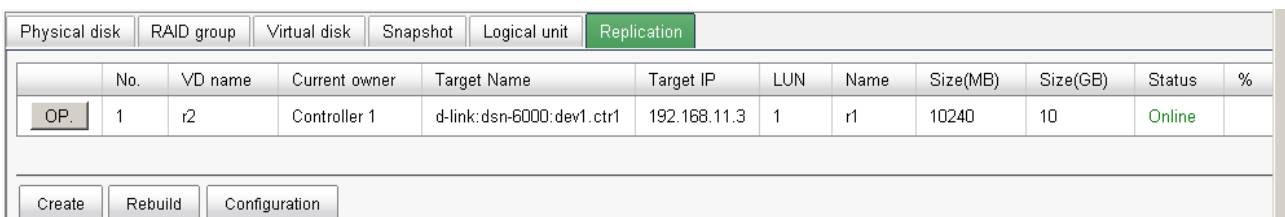

Figure 5.11.11

- **Run the replication job**

1. Click the **“OP”** button on the replication job to open operation menu. Click **“Start”** to run the replication job.

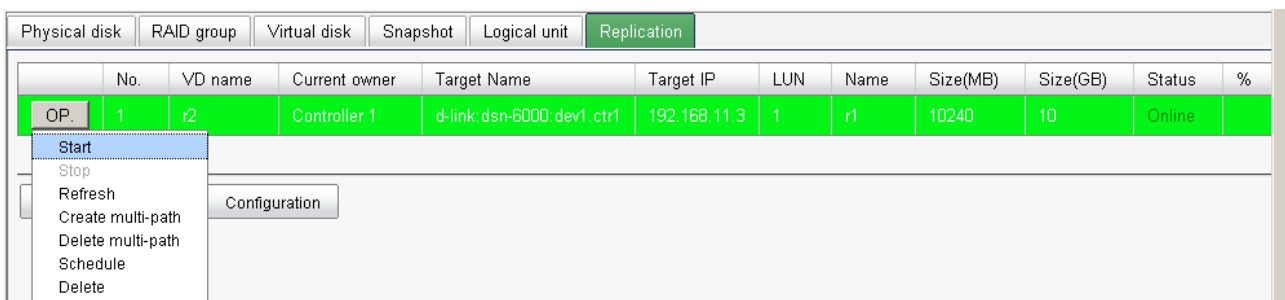

Figure 5.11.12

2. Click **“Start”** again to confirm the execution of the replication job.

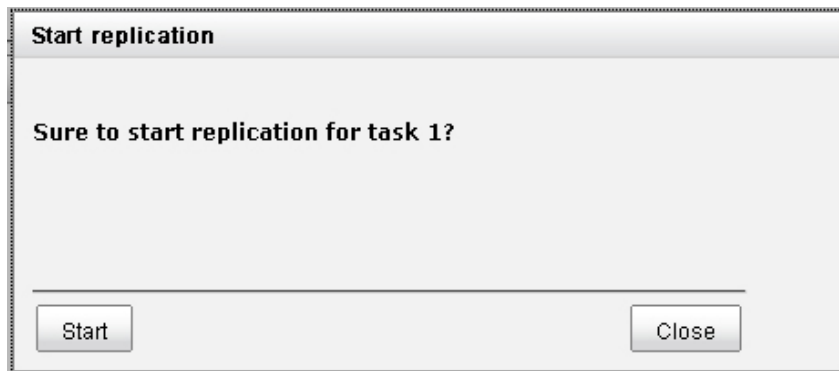

Figure 5.11.13

3. User can monitor the replication job from the **“Status”** information and the progress is expressed by percentage.

Physical disk RAID group Virtual disk Snapshot Logical unit Replication										
	No.	VD name	Current owner	Target Name	Target IP	LUN	Name	Size(MB)	Size(GB)	Status
OP.	1	r2	Controller 1	d-link:dsn-6000:dev1.ctr1	192.168.11.3	1	r1	10240	10	Replicating

Create Rebuild Configuration

Figure 5.11.14

- **Create multi-path on the replication job**

1. Click the **“Create multi-path”** in the operation menu of the replication job.

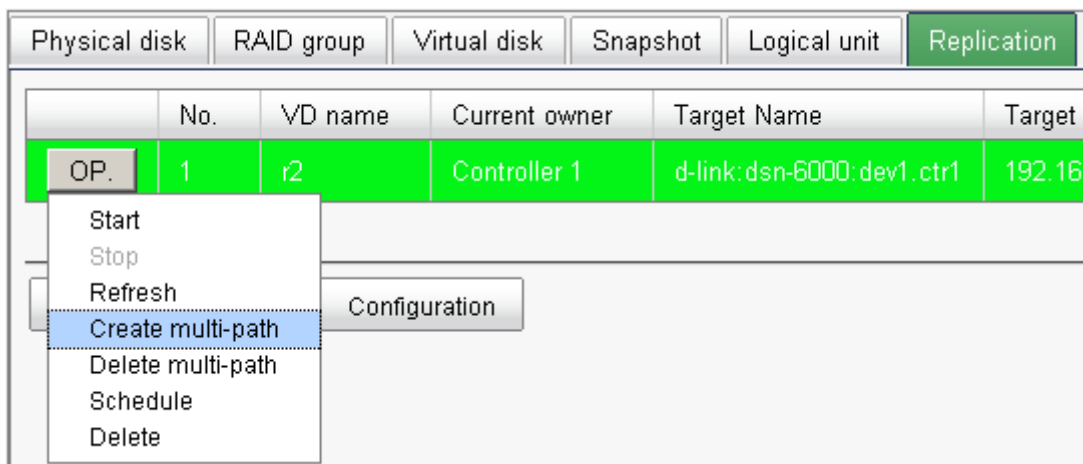

Figure 5.11.15

2. Enter the IP of iSCSI port on controller 2 of the target IP SAN storage.

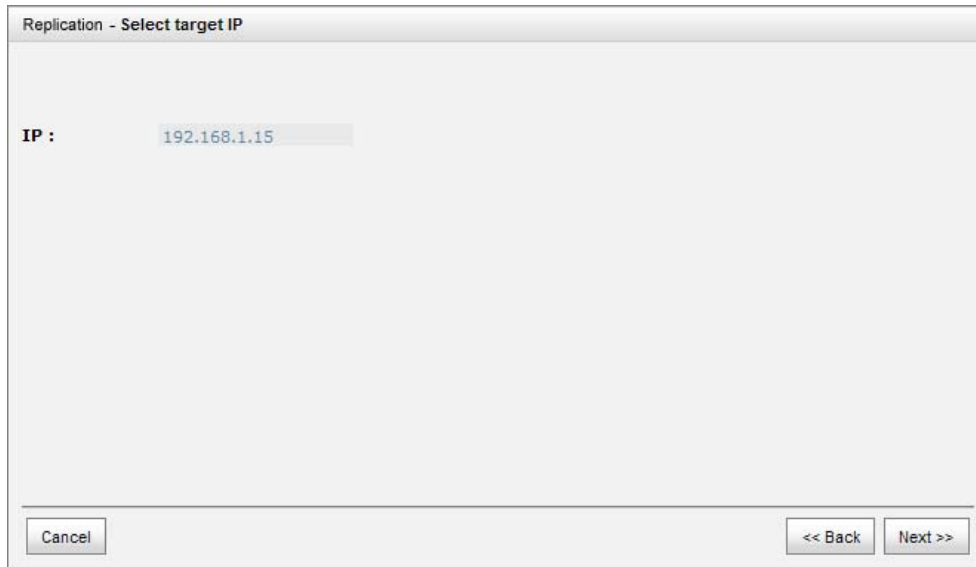

Figure 5.11.16

3. Select the iSCSI node to log on and click **"Next"**.

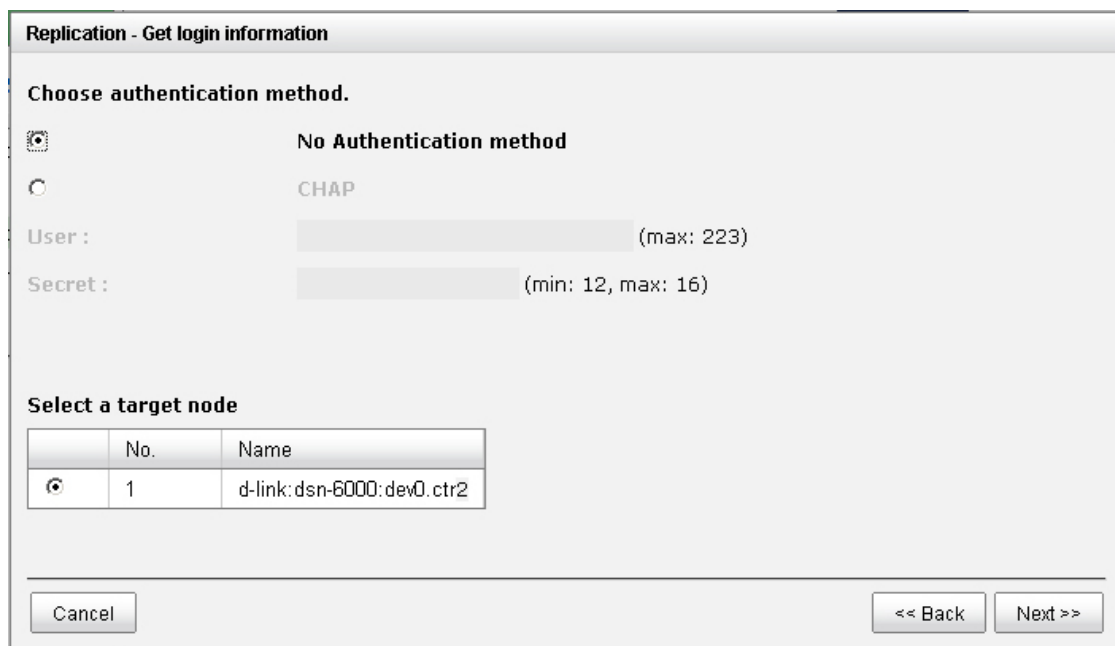

Figure 5.11.17

4. Choose the same target VD and click **"Next"**.

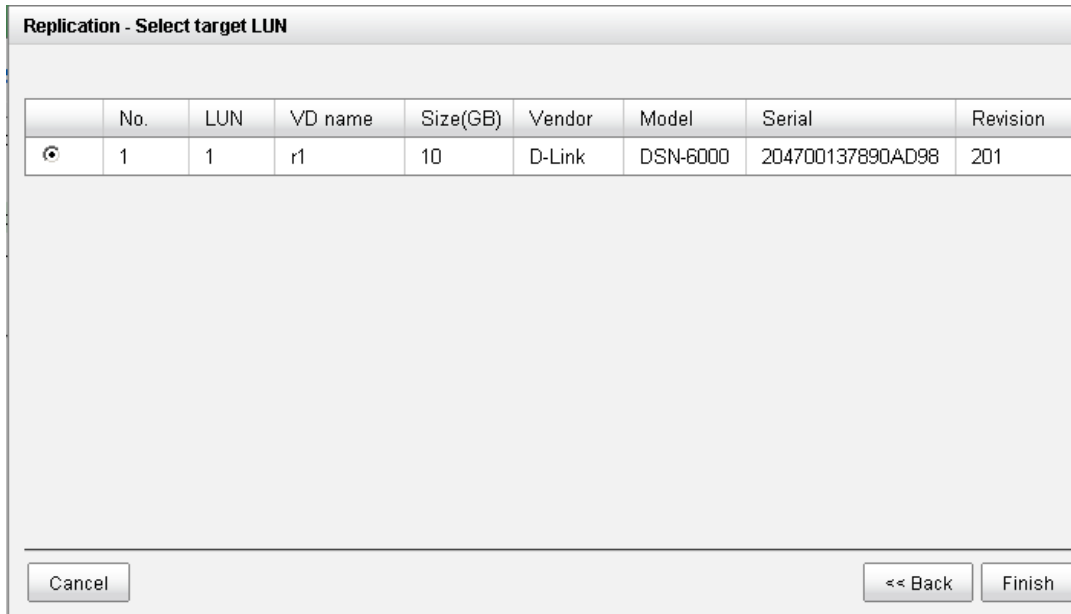

Figure 5.11.18

5. A new target will be added in this replication job as a redundancy path.

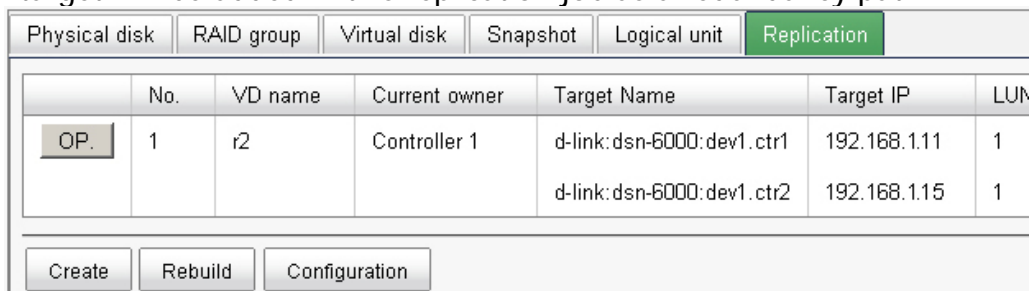

Figure 5.11.19

- **Configure the replication job to run by schedule**

1. Click **“Schedule”** in the operation menu of the replication job.

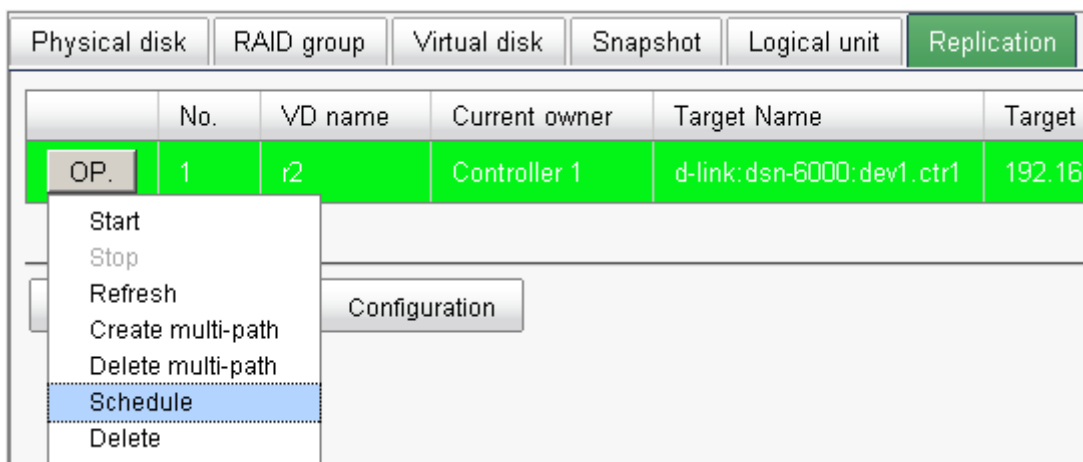

Figure 5.11.20

- The replication job can be scheduled to run by day, by week or by month. The execution time can be configurable per user's need.

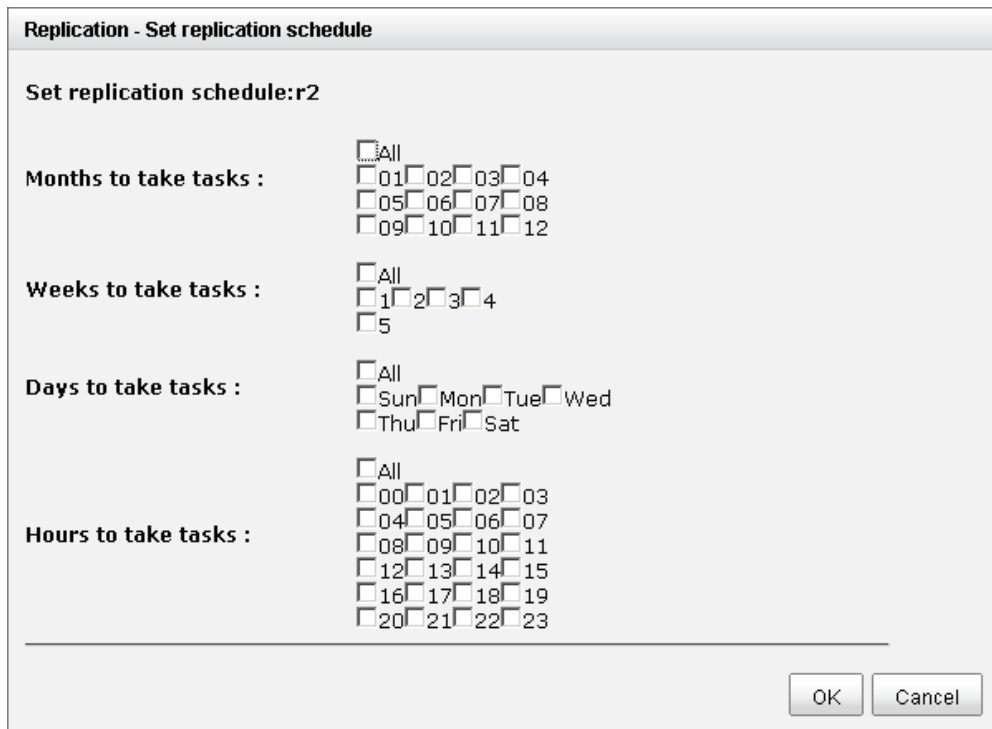

Figure 5.11.21

- Configure the snapshot space**

The **Replication** uses **Snapshot** technique of **D-LINK**, to help user to replicate the data without stop accessing to the source VD. If the snapshot space is not configured on the source VD in advance, the IP SAN storage will allocate snapshot space for the source VD automatically when the replication job is created. The default snapshot space allocated by the IP SAN storage is double size of the source VD. If the free space of the RG which the source VD resides in is less than double size of the source VD, the replication job will fail and pops up the error message.

To prevent this problem, user has to make sure the RG has enough free space for the snapshot space of source VD, or user has to configure the snapshot space of the source VD manually before the replication job is created.

- To configure the snapshot space settings of Replication, click the **"configuration"** button.

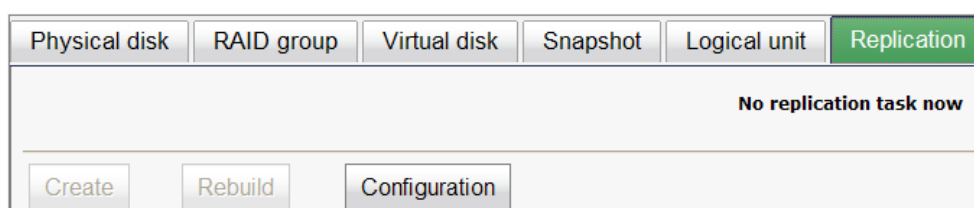

There are three settings in the **Replication configuration** menu,

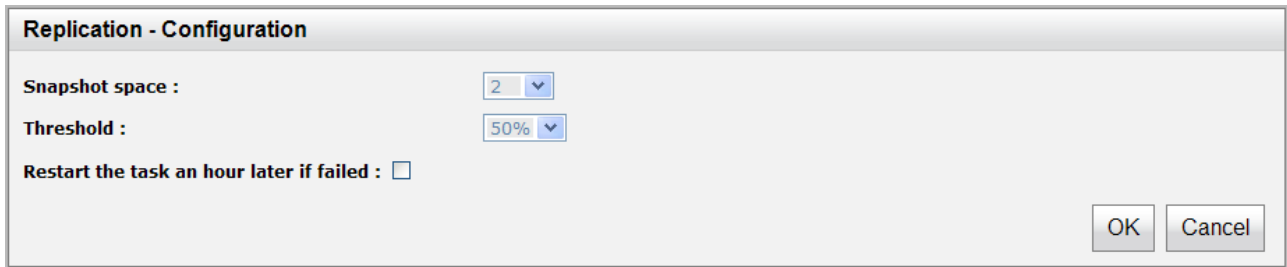

Replication - Configuration

Snapshot space : 2

Threshold : 50%

Restart the task an hour later if failed :

OK Cancel

The **Snapshot space** specifies the ratio of snapshot space allocated to the source VD automatically when the snapshot space is not configured in advance. The default ratio is 2 to 1. It means when the replication job is creating, the IP SAN storage will automatically use the free space of RG to create a snapshot space which size is double of the source VD.

The **Threshold** setting will monitor the utilization of snapshot space. When the used snapshot space achieves the threshold, the IP SAN storage will automatically take a new snapshot and start the replication job. The purpose of threshold is to prevent the incremental copy fail immediately when running out of snapshot space. For example, the default threshold is 50%, and the system will check the snapshot space every hour. When the snapshot space is used over 50%, the IP SAN storage will automatically replicate data from the source VD to the target VD. Next time, when the rest snapshot space has been used over 50%, in other words, the total snapshot space has been used over 75%, the IP SAN storage will start the replication job again.

The **Restart the task an hour later if failed** setting is used when running out of snapshot space, the replication job will stop because there is no more available snapshot space. If this option has been check, the IP SAN storage will automatically clear the snapshots to release snapshot space, and the replication job will restart the task after an hour.



Caution

These two settings, **Threshold** and **Restart the task an hour later if failed**, will take effect only when the replication job is configured to run by schedule.

5.12 VLAN

VLAN (Virtual Local Area Network) is a logical grouping mechanism implemented on switch device using software rather than a hardware solution. VLANs are collections of switching ports that comprise a single broadcast domain. It allows network traffic to flow more efficiently within these logical subgroups. Please consult your network switch user manual for VLAN setting instructions. Most of the work is done at the switch part. All you need to do is to make sure that your iSCSI port's VLAN ID matches that of switch port.

- **VLAN ID is a 12-bit number.**
PCP(Priority Code Point) is a 3-bit number and reserved for QoS.

VLAN IDs range from 2 to 4094 with 0, 1, and 4095 reserved for special purposes (they are different from switches to switches.). Our PCP definition comply with IEEE 802.1p protocol, ranging from 0 to 7, with 0 as the default value. In normal cases, you don't need to set PCP value. Using the default setting will do just fine.

- **Assign VLAN ID to iSCSI ports**

1. Go to "iSCSI Configuration", select "NIC" tab.
2. Click on "OP" button of which port you prefer. Select "Set VLAN ID".

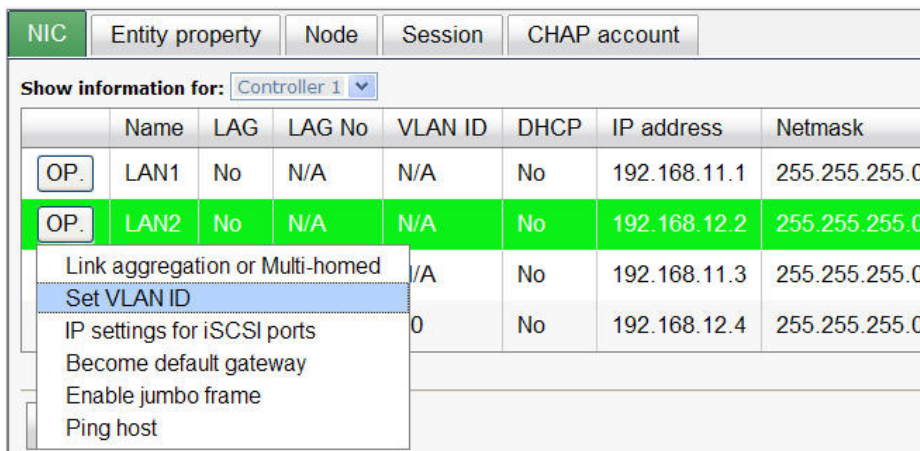

Figure 5.12.1

3. Put in the same VLAN ID of the corresponding switch port that the iSCSI port is plugged in. And click "Ok".

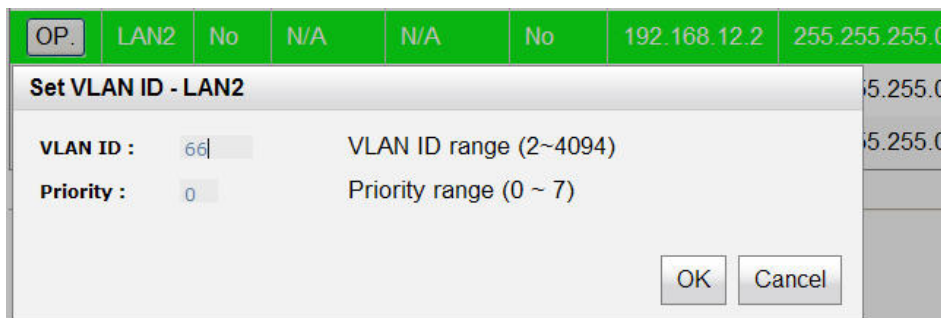

Figure 5.12.2

4. VLAN ID 66 for LAN2 is set properly.

NIC							
Entity property		Node	Session	CHAP account			
Show information for: Controller 1							
	Name	LAG	LAG No	VLAN ID	DHCP	IP address	Netmask
<input type="button" value="OP."/>	LAN1	No	N/A	N/A	No	192.168.11.1	255.255.255.0
<input type="button" value="OP."/>	LAN2	No	N/A	66	No	192.168.12.2	255.255.255.0
<input type="button" value="OP."/>	LAN3	No	N/A	N/A	No	192.168.11.3	255.255.255.0
<input type="button" value="OP."/>	LAN4	No	N/A	10	No	192.168.12.4	255.255.255.0
Aggregation							

Figure 5.12.3

- Assign VLAN ID to LAG(Trunking or LACP)

1. After creating LAG, press "OP" button next to the LAG, and select "Set VLAN ID".

	Name	LAG	LAG No	VLAN ID	DHCP	IP address
<input type="button" value="OP."/>	LAN1	No	N/A	11	No	192.168.11.5
<input type="button" value="OP."/>	LAN2	Trunking	0	N/A	No	192.168.12.6
<input type="button" value="OP."/>	LAN3	Trunking	0	N/A	No	192.168.12.6
				12	No	192.168.12.8

Delete link aggregation
 Link aggregation or Multi-homed
Set VLAN ID
 IP settings for iSCSI ports
 Become default gateway
 Enable jumbo frame
 Ping host

Figure 5.12.4

2. Put in the VLAN ID and click ok. VLAN ID of LAG 0 is properly set.

	Name	LAG	LAG No	VLAN ID	DHCP	IP address
<input type="button" value="OP."/>	LAN1	No	N/A	11	No	192.168.11.5
<input type="button" value="OP."/>	LAN2	Trunking	0	100	No	192.168.12.6
<input type="button" value="OP."/>	LAN3	Trunking	0	100	No	192.168.12.6
<input type="button" value="OP."/>	LAN4	No	N/A	12	No	192.168.12.8
Aggregation						

Figure 5.12.5

3. If iSCSI ports are assigned with VLAN ID before creating aggregation takes place, aggregation will remove VLAN ID. You need to repeat step 1 and step 2 to set VLAN ID for the aggregation group.

- **Assign VLAN ID to replication port**

Please consult figure 5.11.3 of 5.11 Replication section for details.

- **Always make sure correct VLAN IDs are assigned to the correct network ports (iSCSI, switch, and host NIC) to ensure valid connections.**

Chapter 6 Troubleshooting

6.1 System buzzer

The system buzzer features are listed below:

1. The system buzzer alarms 1 second when system boots up successfully.
2. The system buzzer alarms continuously when there is error occurred. The alarm will be stopped after error resolved or be muted.
3. The alarm will be muted automatically when the error is resolved. E.g., when RAID 5 is degraded and alarm rings immediately, user changes / adds one physical disk for rebuilding. When the rebuilding is done, the alarm will be muted automatically.

6.2 Event notifications

- PD events

Level	Type	Description
INFO	PD inserted	Disk <slot> is inserted into system
WARNING	PD removed	Disk <slot> is removed from system
ERROR	HDD read error	Disk <slot> read block error
ERROR	HDD write error	Disk <slot> write block error
ERROR	HDD error	Disk <slot> is disabled
ERROR	HDD IO timeout	Disk <slot> gets no response
INFO	PD upgrade started	PD [<string>] starts upgrading firmware process.
INFO	PD upgrade finished	PD [<string>] finished upgrading firmware process.
WARNING	PD upgrade failed	PD [<string>] upgrade firmware failed.

- HW events

Level	Type	Description
WARNING	ECC single	Single-bit ECC error is detected at <address>
ERROR	ECC multiple	Multi-bit ECC error is detected at <address>
INFO	ECC dimm	ECC memory is installed
INFO	ECC none	Non-ECC memory is installed
INFO	SCSI bus reset	Received SCSI Bus Reset event at the SCSI Bus <number>
ERROR	SCSI host error	SCSI Host allocation failed
ERROR	SATA enable device fail	Failed to enable the SATA pci device
ERROR	SATA EDMA mem fail	Failed to allocate memory for SATA EDMA
ERROR	SATA remap mem fail	Failed to remap SATA memory io spcae

ERROR	SATA PRD mem fail	Failed to init SATA PRD memory manager
ERROR	SATA revision id fail	Failed to get SATA revision id
ERROR	SATA set reg fail	Failed to set SATA register
ERROR	SATA init fail	Core failed to initialize the SATA adapter
ERROR	SATA diag fail	SATA Adapter diagnostics failed
ERROR	Mode ID fail	SATA Mode ID failed
ERROR	SATA chip count error	SATA Chip count error
INFO	SAS port reply error	SAS HBA port <number> reply terminated abnormally
INFO	SAS unknown port reply error	SAS frontend reply terminated abnormally
INFO	FC port reply error	FC HBA port <number> reply terminated abnormally
INFO	FC unknown port reply error	FC frontend reply terminated abnormally

- **EMS events**

Level	Type	Description
INFO	Power install	Power(<string>) is installed
ERROR	Power absent	Power(<string>) is absent
INFO	Power restore	Power(<string>) is restored to work.
ERROR	Power fail	Power(<string>) is not functioning
WARNING	Power detect	PSU signal detection(<string>)
INFO	Fan restore	Fan(<string>) is restored to work.
ERROR	Fan fail	Fan(<string>) is not functioning
INFO	Fan install	Fan(<string>) is installed
ERROR	Fan not present	Fan(<string>) is not present
ERROR	Fan over speed	Fan(<string>) is over speed
WARNING	Thermal level 1	System temperature(<string>) is higher.
ERROR	Thermal level 2	System Overheated(<string>)!!!
ERROR	Thermal level 2 shutdown	System Overheated(<string>)!!! The system will auto-shutdown immediately.
ERROR	Thermal level 2 CTR shutdown	The controller will auto shutdown immediately, reason [Overheated(<string>)].
WARNING	Thermal ignore value	Unable to update thermal value on <string>
WARNING	Voltage level 1	System voltage(<string>) is higher/lower.
ERROR	Voltage level 2	System voltages(<string>) failed!!!
ERROR	Voltage level 2 shutdown	System voltages(<string>) failed!!! The system will auto-shutdown immediately.
ERROR	Voltage level 2 CTR shutdown	The controller will auto shutdown immediately, reason [Voltage abnormal(<string>)].
INFO	UPS OK	Successfully detect UPS
WARNING	UPS fail	Failed to detect UPS
ERROR	UPS AC loss	AC loss for system is detected
ERROR	UPS power low	UPS Power Low!!! The system will auto-shutdown immediately.
WARNING	SMART T.E.C.	Disk <slot> S.M.A.R.T. Threshold Exceed Condition occurred for attribute <string>
WARNING	SMART fail	Disk <slot>: Failure to get S.M.A.R.T information
WARNING	RedBoot failover	RedBoot failover event occurred
WARNING	Watchdog shutdown	Watchdog timeout shutdown occurred
WARNING	Watchdog reset	Watchdog timeout reset occurred

- **RMS events**

Level	Type	Description
INFO	Console Login	<username> login from <IP or serial console> via Console UI
INFO	Console Logout	<username> logout from <IP or serial console> via Console UI
INFO	Web Login	<username> login from <IP> via Web UI
INFO	Web Logout	<username> logout from <IP> via Web UI
INFO	Log clear	All event logs are cleared
WARNING	Send mail fail	Failed to send event to <email>.

- **Snapshot events**

Level	Type	Description
WARNING	Snap mem	Failed to allocate snapshot memory for VD <name>.
WARNING	Snap space overflow	Failed to allocate snapshot space for VD <name>.
WARNING	Snap threshold	The snapshot space threshold of VD <name> has been reached.
INFO	Snap delete	The snapshot VD <name> has been deleted.
INFO	Snap auto delete	The oldest snapshot VD <name> has been deleted to obtain extra snapshot space.
INFO	Snap take	A snapshot on VD <name> has been taken.
INFO	Snap set space	Set the snapshot space of VD <name> to <number> MB.
INFO	Snap rollback started	Snapshot rollback of VD <name> has been started.
INFO	Snap rollback finished	Snapshot rollback of VD <name> has been finished.
WARNING	Snap quota reached	The quota assigned to snapshot <name> is reached.
INFO	Snap clear space	The snapshot space of VD <name> is cleared

- **iSCSI events**

Level	Type	Description
INFO	iSCSI login accepted	iSCSI login from <IP> succeeds.
INFO	iSCSI login rejected	iSCSI login from <IP> was rejected, reason [<string>]
INFO	iSCSI logout recvd	iSCSI logout from <IP> was received, reason [<string>].

- **Battery backup events**

Level	Type	Description
INFO	BBM start syncing	Abnormal shutdown detected, start flushing battery-backed data (<number> KB).
INFO	BBM stop syncing	Abnormal shutdown detected, flushing battery-backed data finished
INFO	BBM installed	Battery backup module is detected

INFO	BBM status good	Battery backup module is good
INFO	BBM status charging	Battery backup module is charging
WARNING	BBM status fail	Battery backup module is failed
INFO	BBM enabled	Battery backup feature is <string>.
INFO	BBM inserted	Battery backup module is inserted
INFO	BBM removed	Battery backup module is removed

- **JBOD events**

Level	Type	Description
INFO	PD upgrade started	JBOD <name> PD [<string>] starts upgrading firmware process.
INFO	PD upgrade finished	JBOD <name> PD [<string>] finished upgrading firmware process.
WARNING	PD upgrade failed	JBOD <name> PD [<string>] upgrade firmware failed.
INFO	PD freed	JBOD <name> PD <slot> has been freed from RG <name>.
INFO	PD inserted	JBOD <name> disk <slot> is inserted into system.
Warning	PD removed	JBOD <name> disk <slot> is removed from system.
ERROR	HDD read error	JBOD <name> disk <slot> read block error
ERROR	HDD write error	JBOD <name> disk <slot> write block error
ERROR	HDD error	JBOD <name> disk <slot> is disabled.
ERROR	HDD IO timeout	JBOD <name> disk <slot> gets no response
INFO	JBOD inserted	JBOD <name> is inserted into system
WARNING	JBOD removed	JBOD <name> is removed from system
WARNING	SMART T.E.C	JBOD <name> disk <slot>: S.M.A.R.T. Threshold Exceed Condition occurred for attribute <string>
WARNING	SMART fail	JBOD <name> disk <slot>: Failure to get S.M.A.R.T information
INFO	PD dedicated spare	Assign JBOD <name> PD <slot> to be the dedicated spare disk of RG <name>.
INFO	PD global spare	Assign JBOD <name> PD <slot> to Global Spare Disks.
ERROR	Config read fail	Config read error occurred at LBA <address>-<address> of JBOD <name> PD <slot>.
ERROR	Config write fail	Config write error occurred at LBA <address>-<address> of JBOD <name> PD <slot>.
WARNING	PD read error	Read error occurred at LBA <address>-<address> of JBOD <name> PD <slot>.
WARNING	PD write error	Write error occurred at LBA <address>-<address> of JBOD <name> PD <slot>.
INFO	PD scrub started	JBOD <name> PD <slot> starts disk scrubbing process.
INFO	PD scrub completed	JBOD <name> PD <slot> completed disk scrubbing process.
WARNING	PS fail	Power Supply of <string> in JBOD <name> is FAIL
INFO	PS normal	Power Supply of <string> in JBOD <name> is NORMAL
WARNING	FAN fail	Cooling fan of <string> in JBOD <name> is FAIL
INFO	FAN normal	Cooling fan of <string> in JBOD <name> is NORMAL
WARNING	Volt warn OV	Voltage of <string> read as <string> in JBOD <name> is WARN OVER
WARNING	Volt warn UV	Voltage of <string> read as <string> in JBOD <name> is WARN UNDER
WARNING	Volt crit OV	Voltage of <string> read as <string> in JBOD <name> is CRIT OVER
WARNING	Volt crit UV	Voltage of <item> read as <string> in JBOD <name> is CRIT UNDER

INFO	Volt recovery	Voltage of <string> in JBOD <string> is NORMAL
WARNING	Therm warn OT	Temperature of <string> read as <string> in JBOD <name> is OT WARNING
WARNING	Therm warn UT	Temperature of <string> read as <string> in JBOD <name> is UT WARNING
WARNING	Therm fail OT	Temperature of <string> read as <string> in JBOD <name> is OT FAILURE
WARNING	Therm fail UT	Temperature of <string> read as <string> in JBOD <name> is UT FAILURE
INFO	Therm recovery	Temperature of <string> in JBOD <name> is NORMAL

- **System maintenance events**

Level	Type	Description
INFO	System shutdown	System shutdown.
INFO	System reboot	System reboot.
INFO	System console shutdown	System shutdown from <string> via Console UI
INFO	System web shutdown	System shutdown from <string> via Web UI
INFO	System button shutdown	System shutdown via power button
INFO	System LCM shutdown	System shutdown via LCM
INFO	System console reboot	System reboot from <string> via Console UI
INFO	System web reboot	System reboot from <string> via Web UI
INFO	System LCM reboot	System reboot via LCM
INFO	FW upgrade start	System firmware upgrade starts.
INFO	FW upgrade success	System firmware upgrade succeeds.
WARNING	FW upgrade failure	System firmware upgrade is failed.
ERROR	IPC FW upgrade timeout	System firmware upgrade timeout on another controller
INFO	Config imported	<string> config imported

- **HAC events**

Level	Type	Description
INFO	RG owner changed	The preferred owner of RG <name> has been changed to controller <number>.
INFO	Force CTR write through	Controller <number> forced to adopt write-through mode on failover.
INFO	Restore CTR cache mode	Controller <number> restored to previous caching mode on failback.
INFO	Failover complete	All volumes in controller <number> completed failover process.
INFO	Failback complete	All volumes in controller <number> completed failback process.
INFO	CTR inserted	Controller <number> is inserted into system
ERROR	CTR removed	Controller <number> is removed from system
ERROR	CTR timeout	Controller <number> gets no response
ERROR	CTR lockdown	Controller <number> is locked down

ERROR	CTR memory NG	Memory size mismatch
ERROR	CTR firmware NG	Firmware version mismatch
ERROR	CTR lowspeed NG	Low speed inter link is down
ERROR	CTR highspeed NG	High speed inter link is down
ERROR	CTR backend NG	SAS expander is down
ERROR	CTR frontend NG	FC IO controller is down
INFO	CTR reboot FW sync	Controller reboot, reason [Firmware synchronization completed]

- **Clone events**

Level	Type	Description
INFO	VD clone started	VD <name> starts cloning process.
INFO	VD clone finished	VD <name> finished cloning process.
WARNING	VD clone failed	The cloning in VD <name> failed.
INFO	VD clone aborted	The cloning in VD <name> was aborted.
INFO	VD clone set	The clone of VD <name> has been designated.
INFO	VD clone reset	The clone of VD <name> is no longer designated.
WARNING	Auto clone error	Auto clone task: <string>.
WARNING	Auto clone no snap	Auto clone task: Snapshot <name> is not found for VD <name>.

- **Replication events**

Level	Type	Description
INFO	Replication portal enabled	LAN<number> is enabled for Replication portal
INFO	Replication portal disabled	Replication portal is disabled
INFO	VD replicate started	VD <name> starts replication process.
INFO	VD replicate finished	VD <name> finished replication process.
WARNING	VD replicate failed	The replication in VD <name> failed.
INFO	VD replicate aborted	The replication in VD <name> was aborted.
INFO	VD set as replica	VD <name> has been configured as a replica.
INFO	VD set as RAID	VD <name> has been configured as a RAID volume.
INFO	VD replica set	The replica of VD <name> has been designated.
INFO	VD replica reset	The replica of VD <name> is no longer designated.
WARNING	Auto qrep not enable	Auto Replication task: Replication is not enabled for VD <name>.
WARNING	Auto qrep error	Auto Replication task: <string>.
WARNING	Auto qrep no snap	Auto Replication task: Snapshot <name> is not found for VD <name>.
INFO	Source replicate started	Remote VD <name> starts replicating to VD <name>.
INFO	Source replicate finished	Remote VD <name> finished replication to VD <name>.
INFO	Source replicate failed	Remote VD <name> failed replication to VD <name>.
INFO	Source replicate aborted	Remote VD <name> aborted replication to VD <name>.

Appendix

A. Certification list

- **iSCSI Initiator (Software)**

OS	Software/Release Number
Microsoft Windows	Microsoft iSCSI Software Initiator Release v2.08 System Requirements: 1. Windows 2000 Server with SP4 2. Windows Server 2003 with SP2 3. Windows Server 2008 with SP2
Linux	The iSCSI Initiators are different for different Linux Kernels. 1. For Red Hat Enterprise Linux 3 (Kernel 2.4), install linux-iscsi-3.6.3.tar 2. For Red Hat Enterprise Linux 4 (Kernel 2.6), use the build-in iSCSI initiator iscsi-initiator-utils-4.0.3.0-4 in kernel 2.6.9 3. For Red Hat Enterprise Linux 5 (Kernel 2.6), use the build-in iSCSI initiator iscsi-initiator-utils-6.2.0.742-0.5.el5 in kernel 2.6.18
Mac	ATTO Xtend SAN iSCSI initiator v3.10 System Requirements: 1. Mac OS X v10.5 or later

For ATTO Xtend SAN iSCSI initiator, it is not free. Please contact your local distributor.

- **GbE iSCSI HBA card**

Vendor	Model
HP	NC380T (PCI-Express, Gigabit, 2 ports, TCP/IP offload, iSCSI offload)
QLogic	QLA4010C (PCI-X, Gigabit, 1 port, TCP/IP offload, iSCSI offload)
QLogic	QLA4052C (PCI-X, Gigabit, 2 ports, TCP/IP offload, iSCSI offload)
QLogic	QLE4062C (PCI-Express, Gigabit, 2 ports, TCP/IP offload, iSCSI offload)

- **GbE NIC**

Vendor	Model
HP	NC7170 (PCI-X, Gigabit, 2 ports)
HP	NC360T (PCI-Express, Gigabit, 2 ports, TCP/IP offload)
IBM	NetXtreme 1000 T (73P4201) (PCI-X, Gigabit, 2 ports, TCP/IP offload)
Intel	PWLA8492MT (PCI-X, Gigabit, 2 ports, TCP/IP offload)

- **GbE Switch**

Vendor	Model
D-Link	All of D-Link Managed Gigabit Switch
Dell	PowerConnect 5324

Dell	PowerConnect 2724
Dell	PowerConnect 2708
HP	ProCurve 1800-24G
Netgear	GS724T
ZyXEL	GS2200

- **Hard drive**

SAS drives are recommended on dual controller system. For SATA drives, SATA bridge boards are required in dual controller configuration.

SAS 3.5"

Vendor	Model
Hitachi	Ultrastar 15K147, HUS151436VLS300, 36GB, 15000RPM, SAS 3.0Gb/s, 16M
Hitachi	Ultrastar 15K300, HUS153073VLS300, 73GB, 15000RPM, SAS 3.0Gb/s, 16M (F/W: A410)
Seagate	Cheetah 15K.4, ST336754SS, 36.7GB, 15000RPM, SAS 3.0Gb/s, 8M
Seagate	Cheetah 15K.5, ST373455SS, 73.4GB, 15000RPM, SAS 3.0Gb/s, 16M
Seagate	Cheetah 15K.5, ST3146855SS, 146.8GB, 15000RPM, SAS 3.0Gb/s, 16M
Seagate	Cheetah 15K.6, ST3450856SS, 450GB, 15000RPM, SAS 3.0Gb/s, 16M (F/W: 003)
Seagate	Cheetah NS, ST3400755SS, 400GB, 10000RPM, SAS 3.0Gb/s, 16M
Seagate	Barracuda ES.2, ST31000640SS, 1TB, 7200RPM, SAS 3.0Gb/s, 16M (F/W: 0002)
Seagate	Cheetah NS.2, ST3600002SS, 600GB, 10000RPM, SAS 2.0, 6.0Gb/s, 16M (F/W: 0004)
Seagate	Cheetah 15K.7, ST3600057SS, 600GB, 15000RPM, SAS 2.0, 6.0Gb/s, 16MB (F/W: 0004)
Seagate	Constellation ES, ST31000424SS, 1TB, 7200RPM, SAS 2.0 6.0Gb/s, 16MB (F/W: 0005)
Seagate	Constellation ES, ST32000444SS, 2TB, 7200RPM, SAS 2.0 6.0Gb/s, 16MB (F/W: 0005)

SAS 2.5"

Vendor	Model
Seagate	Savvio 10K.3, ST9300603SS, 300GB, 10000RPM, SAS 2.0, 6.0Gb/s, 16M (F/W: 0003)
Seagate	Savvio 15K.2, ST9146852SS, 147GB, 15000RPM, SAS 2.0, 6.0Gb/s, 16M (F/W: 0002)
Seagate	Constellation, ST9500430SS, 500GB, 7200RPM, SAS 2.0, 6.0Gb/s, 16M (F/W: 0001)

SATA 3.5"

Vendor	Model
Hitachi	Deskstar 7K250, HDS722580VLSA80, 80GB, 7200RPM, SATA, 8M
Hitachi	Deskstar E7K500, HDS725050KLA360, 500GB, 7200RPM, SATA II, 16M
Hitachi	Deskstar 7K80, HDS728040PLA320, 40GB, 7200RPM, SATA II, 2M
Hitachi	Deskstar T7K500, HDT725032VLA360, 320GB, 7200RPM, SATA II, 16M
Hitachi	Deskstar P7K500, HDP725050GLA360, 500GB, 7200RPM, SATA II, 16M (F/W: 0001)

	K2A0AD1A)
Hitachi	Deskstar E7K1000, HDE721010SLA330, 1TB, 7200RPM, SATA 3.0Gb/s, 32MB, NCQ (F/W: ST60A3AA)
Hitachi	UltraStar A7K2000, HUA722020ALA330, 2TB, 7200RPM, SATA 3.0Gb/s, 32MB, NCQ (F/W: JKAOA20N)
Maxtor	DiamondMax Plus 9, 6Y080M0, 80GB, 7200RPM, SATA, 8M
Maxtor	DiamondMax 11, 6H500F0, 500GB, 7200RPM, SATA 3.0Gb/s, 16M
Samsung	SpinPoint P80, HDSASP0812C, 80GB, 7200RPM, SATA, 8M
Seagate	Barracuda 7200.7, ST380013AS, 80GB, 7200RPM, SATA 1.5Gb/s, 8M
Seagate	Barracuda 7200.7, ST380817AS, 80GB, 7200RPM, SATA 1.5Gb/s, 8M, NCQ
Seagate	Barracuda 7200.8, ST3400832AS, 400GB, 7200RPM, SATA 1.5Gb/s, 8M, NCQ
Seagate	Barracuda 7200.9, ST3500641AS, 500GB, 7200RPM, SATA 3.0Gb/s, 16M, NCQ
Seagate	Barracuda 7200.11, ST3500320AS, 500GB, 7200RPM, SATA 3.0Gb/s, 32M, NCQ
Seagate	Barracuda 7200.11, ST31000340AS, 1TB, 7200RPM, SATA 3.0Gb/s, 32M, NCQ
Seagate	Barracuda 7200.11, ST31500341AS, 1.5TB, 7200RPM, SATA 3.0Gb/s, 32M, NCQ (F/W: SD17)
Seagate	NL35.2, ST3400633NS, 400GB, 7200RPM, SATA 3.0Gb/s, 16M
Seagate	NL35.2, ST3500641NS, 500GB, 7200RPM, SATA 3.0Gb/s, 16M
Seagate	Barracuda ES, ST3500630NS, 500GB, 7200RPM, SATA 3.0Gb/s, 16M
Seagate	Barracuda ES, ST3750640NS, 750GB, 7200RPM, SATA 3.0Gb/s, 16M
Seagate	Barracuda ES.2, ST31000340NS, 1TB, 7200RPM, SATA 3.0Gb/s, 32M (F/W: SN06)
Seagate	SV35.5, ST3500410SV, 500GB, 7200 RPM, SATA 3.0Gb/s, 16M, NCQ (F/W: CV11)
Seagate	Constellation ES, ST31000524NS, 1TB, 7200RPM, SATA 3.0Gb/s, 32M, NCQ (F/W: SN11)
Western Digital	Caviar SE, WD800JD, 80GB, 7200RPM, SATA 3.0Gb/s, 8M
Western Digital	Caviar SE, WD1600JD, 160GB, 7200RPM, SATA 1.5Gb/s, 8M
Western Digital	Caviar RE2, WD4000YR, 400GB, 7200RPM, SATA 1.5Gb/s, 16M, NCQ
Western Digital	Caviar RE16, WD5000AAKS, 500GB, 7200RPM, SATA 3.0Gb/s, 16M
Western Digital	RE2, WD4000YS, 400GB, 7200RPM, SATA 3.0Gb/s, 16M
Western Digital	RE2, WD5000ABYS, 500GB, 7200RPM, SATA 3.0Gb/s, 16M, NCQ
Western Digital	RE2-GP, WD1000FYPS, 1TB, 7200RPM, SATA 3.0Gb/s, 16M
Western Digital	RE3, WD1002FBYS, 1000GB, 7200RPM, SATA 3.0Gb/s, 32M, NCQ (F/W: 03.00C05)
Western Digital	RE4, WD2002FYPS, 2TB, IntelliPower, SATA 3.0Gb/s, 64M, NCQ (F/W: 04.05G04)
Western Digital	RE4-GP, WD2002FYPS, 2TB, IntelliPower, SATA 3.0Gb/s, 64M, NCQ (F/W: 04.01G01)
Western Digital	RE4, WD2003FYYS, 2TB, 7200RPM, SATA 3.0Gb/s, 64M, NCQ (F/W: 01.01D01)
Western Digital	RE4, WD1003FBYX, 1TB, 7200RPM, SATA 3.0Gb/s, 64M, NCQ (F/W: 01.01V01)
Western Digital	RE4, WD5003ABYX, 500GB, 7200RPM, SATA 3.0Gb/s, 64M, NCQ (F/W: 01.01S01)
Western Digital	Raptor, WD360GD, 36.7GB, 10000RPM, SATA 1.5Gb/s, 8M
Western Digital	VelociRaptor, WD3000HLFS, 300GB, 10000RPM, SATA 3.0Gb/s, 16M (F/W: 04.04V01)

SATA 2.5"

Vendor	Model
Seagate	Constellation, ST9500530NS, 500GB, 7200RPM, SATA 3.0Gb/s, 32M (F/W: SN02)

B. Microsoft iSCSI initiator

Here is the step by step to setup Microsoft iSCSI Initiator. Please visit Microsoft website for latest iSCSI initiator. This example is based on Microsoft Windows Server 2008 R2.

- **Connect**

1. Run Microsoft iSCSI Initiator.
2. Input IP address or DNS name of the target. And then click **“Quick Connect”**.

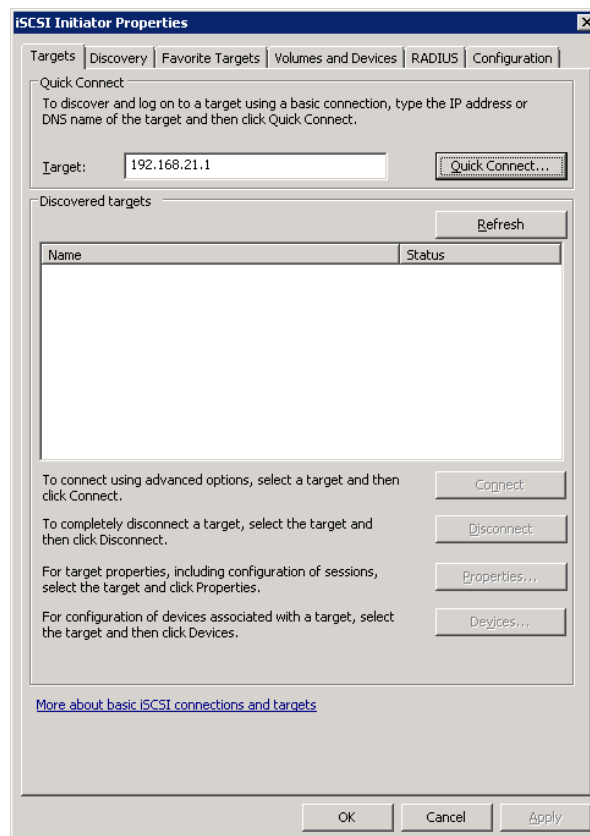

Figure B.1

3. Click **“Done”**.

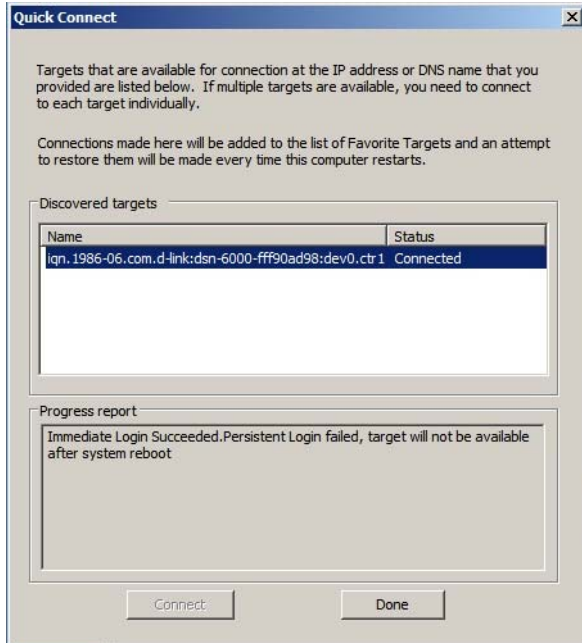

Figure B.2

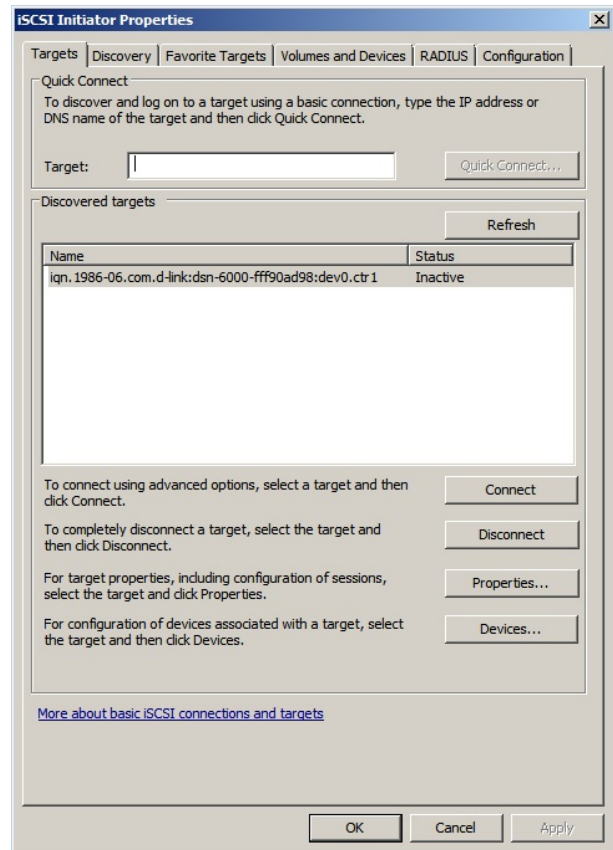

Figure B.3

4. It can connect to an iSCSI disk now.

- **MPIO**

5. If running MPIO, please continue.
6. Click **"Discovery"** tab to connect the second path.
7. Click **"Discover Portal"**. Input IP address or DNS name of the target.

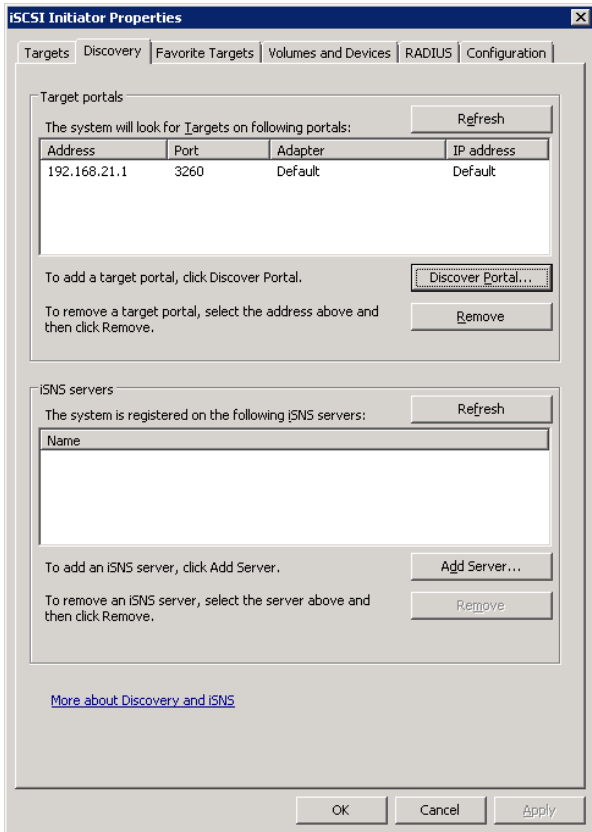

Figure B.4

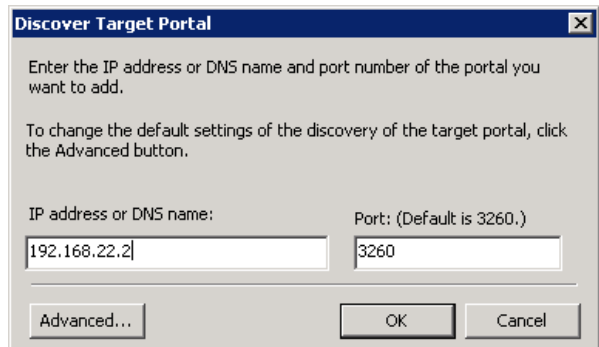

Figure B.5

8. Click "OK".

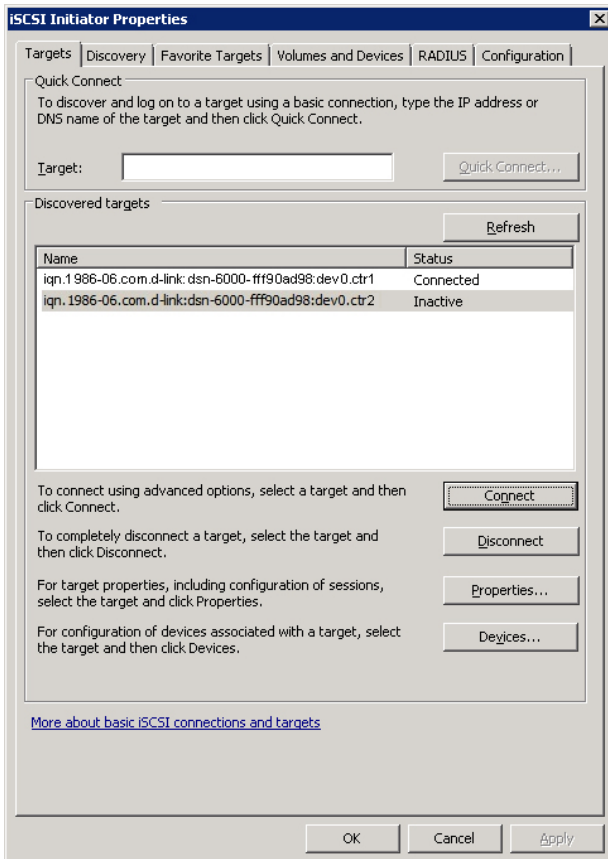

Figure B.6

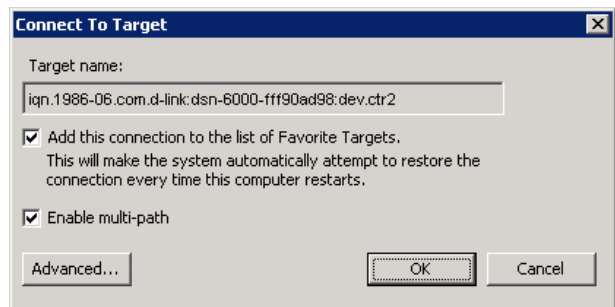

Figure B.7

9. Click **"Targets"** tab, select the second path, and then click **"Connect"**.
10. Enable **"Enable multi-path"** checkbox. Then click **"OK"**.
11. Done, it can connect to an iSCSI disk with MPIO.

- **MC/S**

12. If running MC/S, please continue.
13. Select one target name, click **"Properties..."**.
14. Click **"MCS..."** to add additional connections.

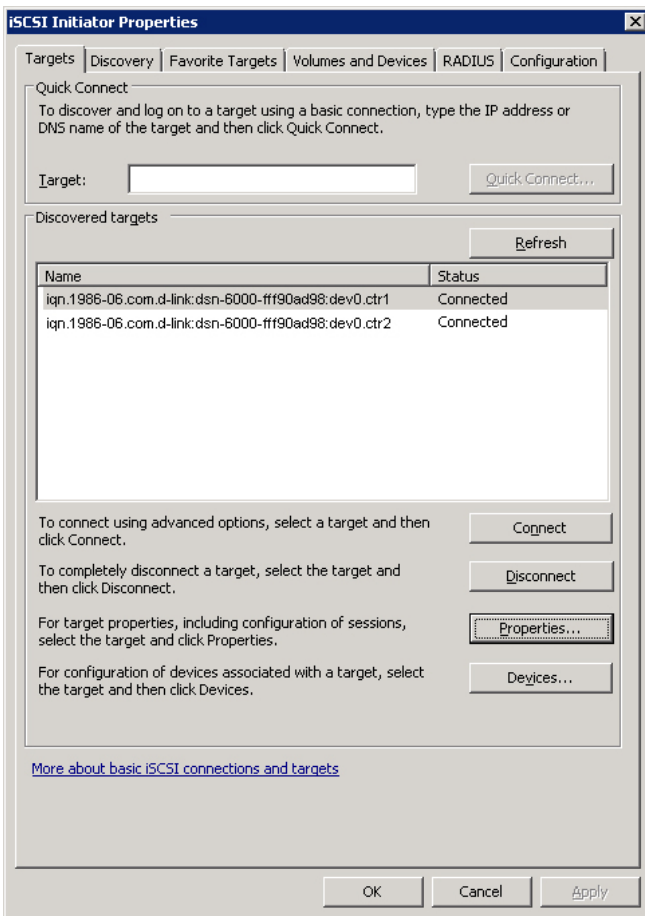

Figure B.8

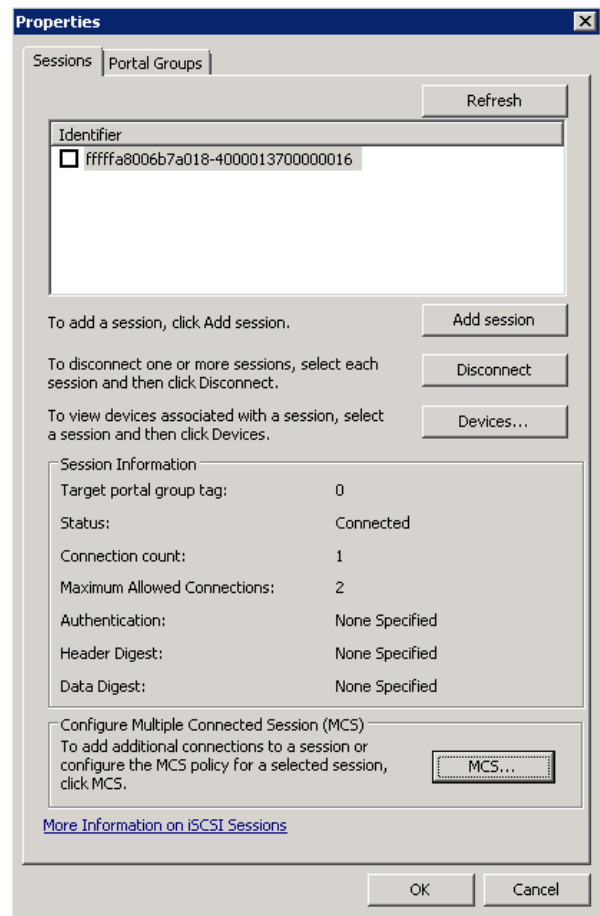

Figure B.9

15. Click **"Add..."**.
16. Click **"Advanced..."**.

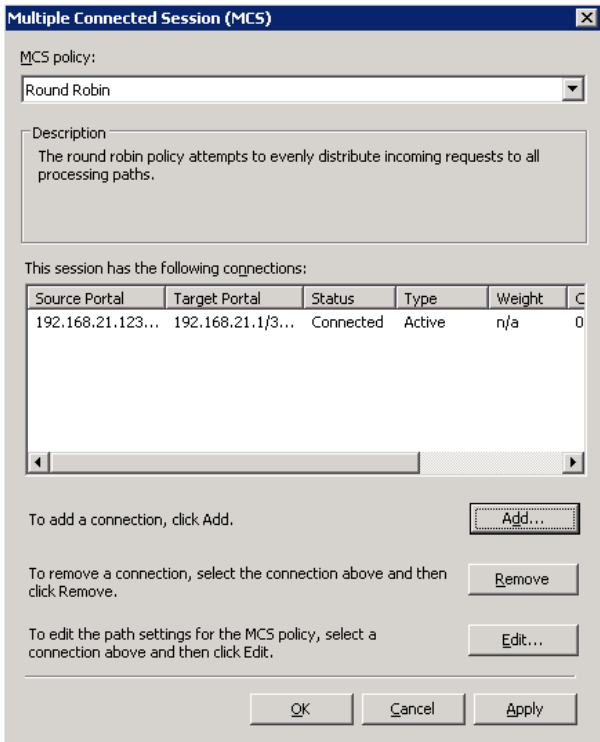

Figure B.10

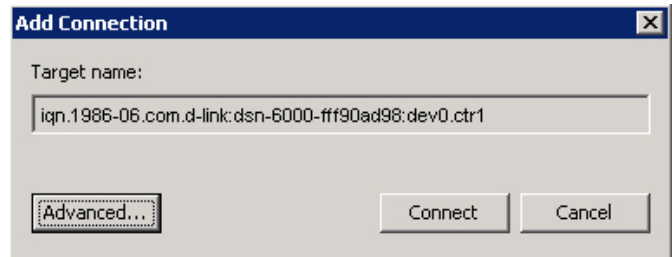

Figure B.11

17. Select Initiator IP and Target portal IP, and then click **"OK"**.
18. Click **"Connect"**.
19. Click **"OK"**.

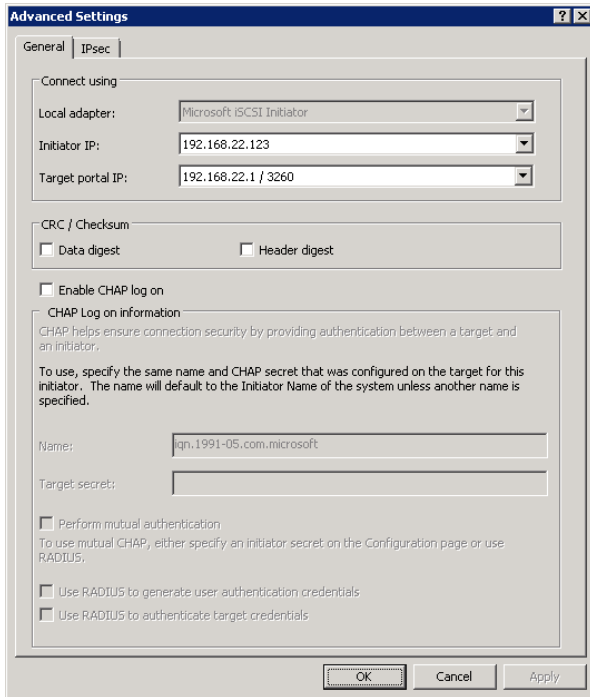

Figure B.12

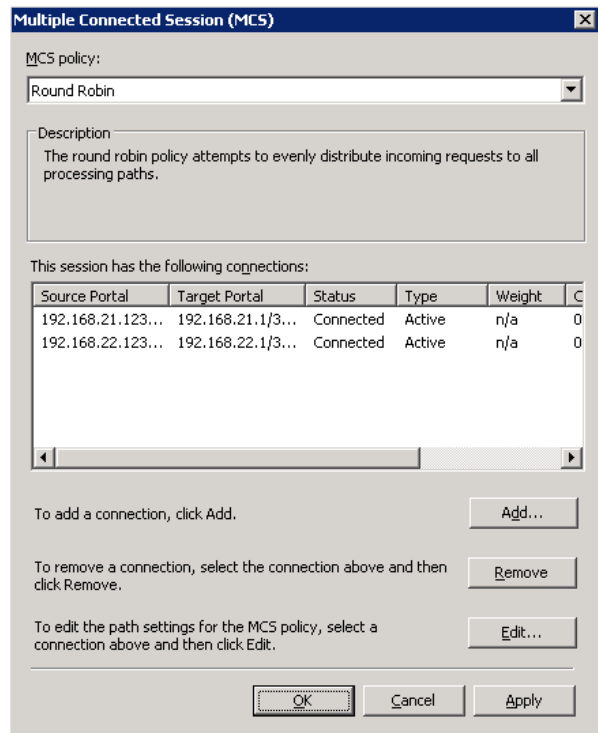

Figure B.13

20. Done.

- **Disconnect**

21. Select the target name, click **“Disconnect”**, and then click **“Yes”**.

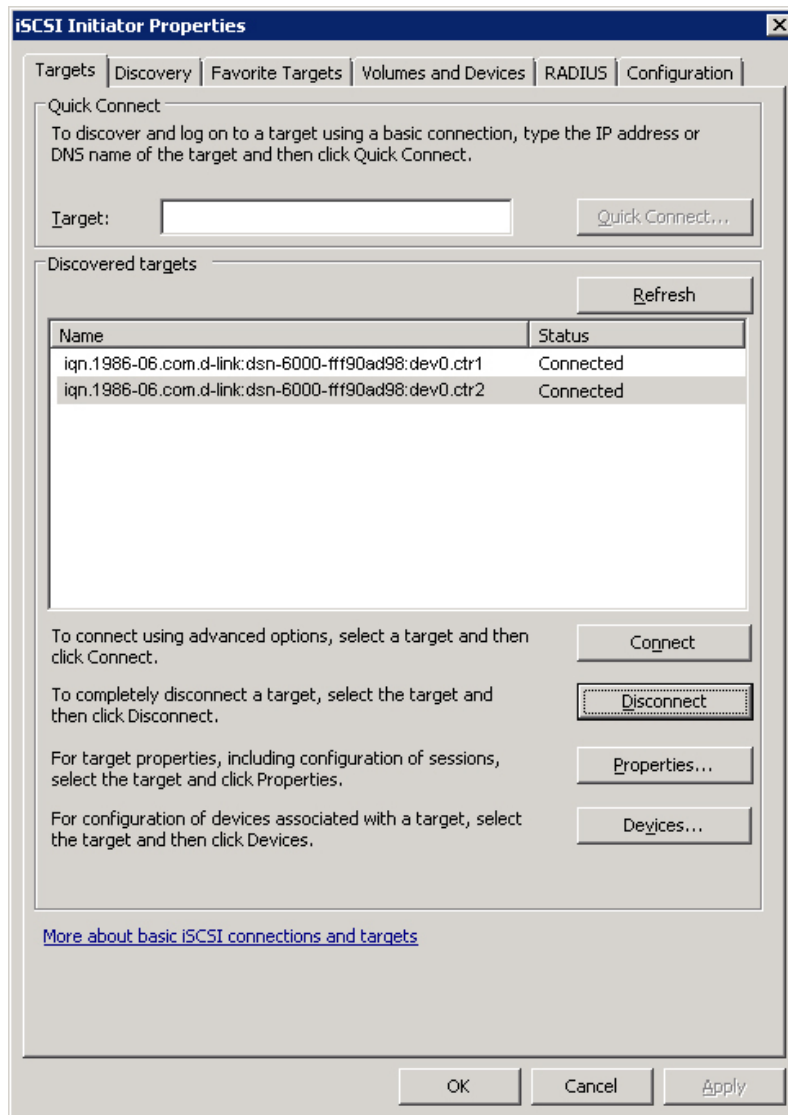

Figure B.14

22. Done, the iSCSI device disconnect successfully.

C. From single controller to dual controllers

This SOP applies to upgrading from DSN-6110 to DSN-6120 as well as from DSN-6410 to DSN-6420. Before you do this, please make sure that either DSN-6110 or DSN-6410 is properly installed according to the manuals, especially the HDD trays. If you are NOT using SAS hard drives, you need to use HDD trays with either multiplexer board or bridge board to install your HDDs in order to utilize the dual controller mode features. Otherwise, the IP SAN system will not be able to recognize the HDDs.

Before you can insert the second controller to the IP SAN storage, the IP SAN storage system should be up and running and looks like the following screenshot in "Maintenance\System". Note that the status is single and you have one controller only.

The screenshot shows the 'System information' page for a DSN-6000. The left sidebar contains navigation options: System configuration, iSCSI configuration, Volume configuration, Enclosure management, Maintenance, Quick installation, and Volume creation wizard. The main content area is a table with the following data:

Item	Information
CPU type	XSC3-IOP8134x Family rev 9 (v5l)
System memory	ECC Unbuffered DDR-II 2048MB
Firmware version	DSN-6000 2.0.1 (build 201102111500)
Serial number	14D64D868E40 (Controller 1 : 500137800390AD98)
Backplane ID	DSN6000
JBOD serial no.	No JBOD connected
JBOD status	No JBOD connected
Status	Single
Replication	Not activated.

You can also verify controller mode in "Maintenance\Upgrade". Check out the "Controller Mode" section.

The screenshot shows the 'Upgrade' page for a DSN-6000. The left sidebar is the same as in the previous screenshot. The main content area is divided into three sections:

- RAID Controller/System(s)**: Includes a 'Browse the firmware to upgrade' field with a search button and a 'Confirm' button.
- JBOD Controller/System(s)**: Includes a 'Choose a JBOD' dropdown menu, a 'Browse the firmware to upgrade' field with a search button, and a 'Confirm' button.
- Controller Mode**: Includes an 'Enter the MAC address for the mode setting' field and an 'Operation mode' dropdown menu set to 'Single'. A 'Confirm' button is at the bottom.

Please follow the steps below to upgrade to dual controller mode.

Step 1

Go to "Maintenance\System". Copy the IP SAN storage serial number.

Item	Information
CPU type	XSC3-IOP8134x Family rev 9 (v5l)
System memory	ECC Unbuffered DDR-II 2048MB
Firmware version	DSN-6000 2.0.1 (build 201102111500)
Serial number	14D64D868E40 (Controller 1 : 500137800390AD98)
Backplane ID	DSN6000
JBOD serial no.	No JBOD connected
JBOD status	No JBOD connected
Status	Single
Replication	Not activated.

Step 2

Go to "Maintenance\Upgrade" and paste the serial number into "Controller Mode" section. Select "Dual" as operation mode.

System information | Event log | **Upgrade** | Reset to factory default | Import and export | Reboot and shutdown

RAID Controller/System(s)

Browse the firmware to upgrade : 瀏覽...

Confirm

JBOD Controller/System(s)

Choose a JBOD:

Browse the firmware to upgrade: 瀏覽...

Confirm

Controller Mode

Enter the MAC address for the mode setting: 14D64D868E40

Operation mode: Single
Dual
Single

Confirm

Step 3

Click "confirm". The system will ask you to shutdown. Please shutdown IP SAN storage.

System information | Event log | **Upgrade** | Reset to factory default | Import and export | Reboot and shutdown

RAID Controller/System(s)

Browse the firmware to upgrade : 瀏覽...

Confirm

JBOD Controller/System(s)

Choose a JBOD:

Browse the firmware to upgrade:

此頁於 http://192.168.105.106 說

Controller operation mode will be changed. Sure?

確定 取消

Confirm

Controller Mode

Enter the MAC address for the mode setting: 14D64D868E40

Operation mode: Dual ▾

Confirm

System information | Event log | **Upgrade** | Reset to factory default | Import and export | Reboot and shutdown

RAID Controller/System(s)

Browse the firmware to upgrade : 瀏覽...

Confirm

JBOD Controller/System(s)

Choose a JBOD:

Browse the firmware to upgrade:

此頁於 http://192.168.105.106 說

Controller operation mode is changed. Please shutdown the system!

確定

Confirm

Controller Mode

Enter the MAC address for the mode setting: 14D64D868E40

Operation mode: Dual ▾

Confirm

Click Ok.

Go to "Maintenance\Reboot and shutdown". Click "Shutdown" to shutdown the system.



Click Ok.



Step 4

Power off DSN-6110 or DSN-6410. Insert the second controller to the IP SAN storage. And then power on the system. The IP SAN storage should now become in dual controller mode as either DSN-6120 or DSN-6420.

You may go to "Maintenance\System information" to check out. The IP SAN storage is running in dual controller mode now.

System information	
Item	Information
CPU type	XSC3-IOP8134x Family rev 9 (v5l)
System memory	ECC Unbuffered DDR-II 2048MB
Firmware version	DSN-6000 2.0.1 (build 201102111500)
Serial number	14D64D868E40 (Controller 1 : 500137800390AD98 Controller 2 : 500137800390A5D8)
Backplane ID	DSN6000
JBOD serial no.	No JBOD connected
JBOD status	No JBOD connected
Status	Normal
Replication	Not activated.